

---

# The ADA Checklist for Existing Facilities

---

## Priority 3 - Toilet Rooms

Based on the 2010 ADA Standards for Accessible Design

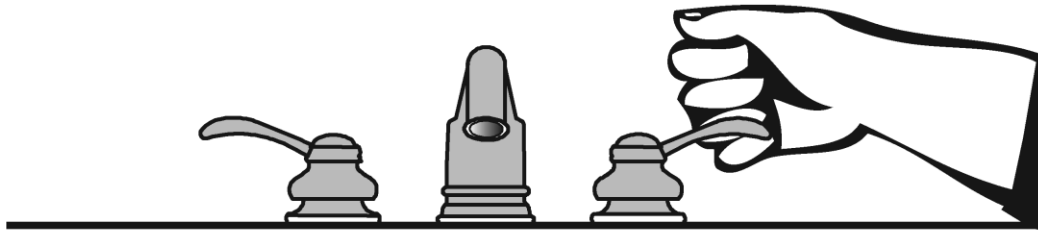

Project

---

Building JUSTICE CENTER

---

Location 1<sup>ST</sup> FLOOR WOMEN'S

---

Date 10/27/2021

---

Surveyors LARRY WEAVER

---

SHERI GAILLARD

---

Contact Information SHERI / 574-242-2508

---

---

**When toilet rooms are open to the public they should be accessible to people with disabilities.**

---



Institute for Human Centered Design  
[www.HumanCenteredDesign.org](http://www.HumanCenteredDesign.org)

Copyright © 2016



ADA National Network  
Questions on the ADA 800-949-4232 voice/tty  
[www.ADAchecklist.org](http://www.ADAchecklist.org)



---

This checklist was produced by the New England ADA Center, a project of the Institute for Human Centered Design and a member of the ADA National Network. This checklist was developed under a grant from the Department of Education, NIDRR grant number H133A060092-09A. However the contents do not necessarily represent the policy of the Department of Education, and you should not assume endorsement by the Federal Government.

Questions or comments on the checklist contact the New England ADA Center at 617-695-0085 voice/tty or [ADAinfo@NewEnglandADA.org](mailto:ADAinfo@NewEnglandADA.org)

For the full set of checklists, including the checklists for recreation facilities visit [www.ADAchecklist.org](http://www.ADAchecklist.org).

**Copyright © 2016 ADA Checklist for Existing Materials. You can freely reproduce and distribute this content. Include proper attribution. But you must get permission before using this content as a fee-based product.**

Priority 3 – Toilet Rooms		Comments	Possible Solutions
<p><b>3.1</b> If toilet rooms are available to the public, is at least one toilet room accessible? (Either one for each sex, or one unisex.)</p> <p>Note: If toilet rooms are chiefly for children, e.g., in elementary schools and day care centers, use the children’s specifications in Toilets - 604.1, 604.8, 604.9, 609.4 and Lavatories and Sinks – 606.2.</p>	<input checked="" type="checkbox"/> Yes <input type="checkbox"/> No	<p>Photo #:</p>	<ul style="list-style-type: none"> <li>• Reconfigure toilet rooms</li> <li>• Combine toilet rooms to create one unisex accessible toilet room</li> <li>•</li> </ul>
<p><b>3.2</b> Are there signs at inaccessible toilet rooms that give directions to accessible toilet rooms? [See 2010 ADA Standards for Accessible Design – 216.8]</p>	<input type="checkbox"/> Yes <input checked="" type="checkbox"/> No	 <p>Photo #:</p>	<ul style="list-style-type: none"> <li>• Install signs</li> <li>•</li> <li>•</li> </ul>
<p><b>3.3</b> If not all toilet rooms are accessible, is there a sign at the accessible toilet room with the International Symbol of Accessibility? [216.8]</p>	<input type="checkbox"/> Yes <input type="checkbox"/> No	 <p>Photo #:</p>	<ul style="list-style-type: none"> <li>• Install sign</li> <li>•</li> <li>•</li> </ul>
Accessible Route			
<p><b>3.4</b> Is there an accessible route to the accessible toilet room? [206.2.4]</p>	<input checked="" type="checkbox"/> Yes <input type="checkbox"/> No	<p>Photo #:</p>	<ul style="list-style-type: none"> <li>• Alter route</li> <li>•</li> <li>•</li> </ul>

**Signs at Toilet Rooms**

**3.5** Do text characters contrast with their backgrounds? [703.5]

Yes  No

Are text characters raised? [703.2]

Yes  No

Is there Braille? [703.3]

Yes  No

Is the sign mounted:  
On the wall on the latch side of the door? [703.4.2]

Yes  No

Note: Signs are permitted on the push side of doors with closers and without hold-open devices.

With clear floor space beyond the arc of the door swing and 45-degree open position, at least 18 x 18 inches centered on the tactile characters? \* [703.4.2]

Yes  No

Measurement:

So the baseline of the lowest character is at least 48 inches above the floor and the baseline of the highest character is no more than 60

Yes  No

Measurement:

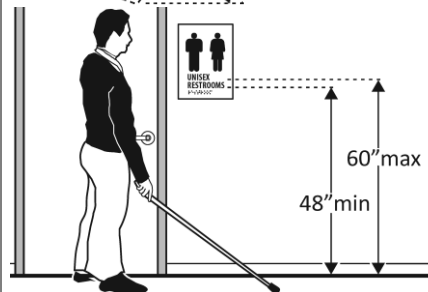
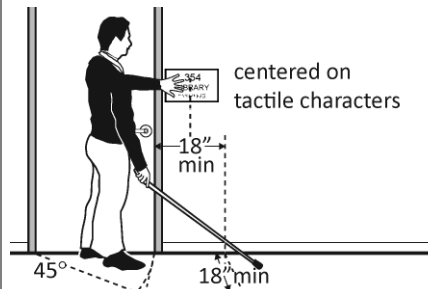
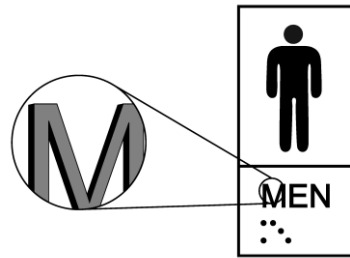

- Install tactile sign
- Relocate sign
- 

\*If constructed before 3/15/2012 and a person may approach within 3 inches of the sign without encountering protruding objects or standing within the door swing, relocation not required

\*If constructed before 3/15/2012 and mounted no higher than 60 inches to the centerline of the sign, relocation is not

<p>inches above the floor? * [703.4.1]</p> <p>Note: If the sign is at double doors with one active leaf, the sign should be on the inactive leaf; if both leaves are active, the sign should be on the wall to the right of the right leaf.</p>			<p>Photo #:</p>	<p>required</p>
---	--	--	-----------------	-----------------

**Entrance**

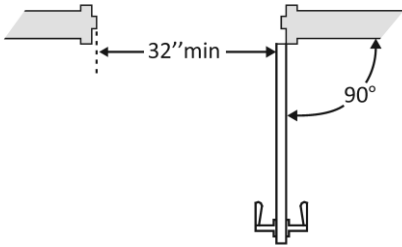
<p><b>3.6</b> Is the door opening width at least 32 inches clear, between the face of the door and the stop, when the door is open 90 degrees? [404.2.3]</p>	<p><input checked="" type="checkbox"/> Yes <input type="checkbox"/> No</p> <p>Measurement: 32.5"</p>		<p>Photo #:</p>	<ul style="list-style-type: none"> <li>• Install offset hinges</li> <li>• Alter the doorway</li> <li>•</li> </ul>
--	--	--	-----------------	---

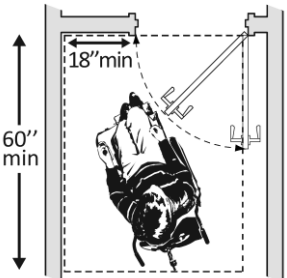

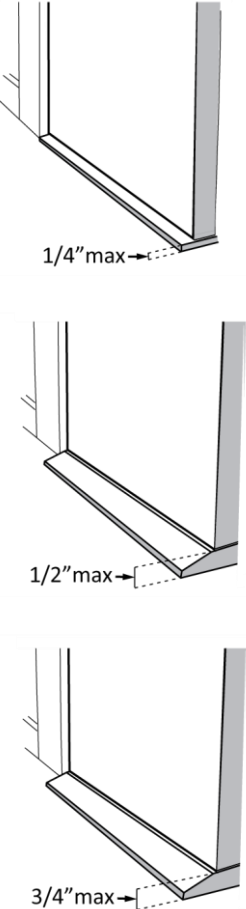
<p><b>3.7</b> If there is a front approach to the pull side of the door is there at least 18 inches of maneuvering clearance beyond the latch side plus 60 inches clear depth?</p> <p>Note: See 2010 Standards 404.2.4 for maneuvering clearance requirements on the push side of the door and side approaches to the pull side of the door</p> <p>On both sides of the door, is the floor surface of the</p>	<p><input type="checkbox"/> Yes <input checked="" type="checkbox"/> No</p> <p>Measurement: 58"</p> <p><input type="checkbox"/> Yes <input type="checkbox"/> No</p>		<p>Photo #:</p>	<ul style="list-style-type: none"> <li>• Remove obstructions</li> <li>• Reconfigure walls</li> <li>• Add automatic door opener</li> </ul>
---	--	--	-----------------	---

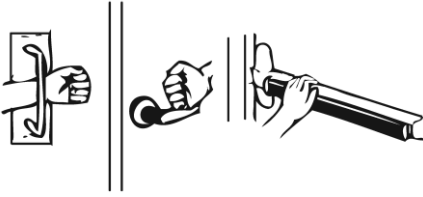
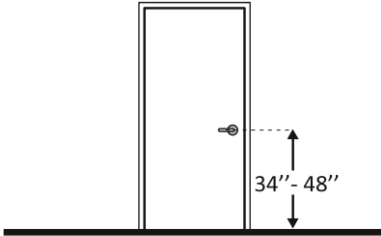
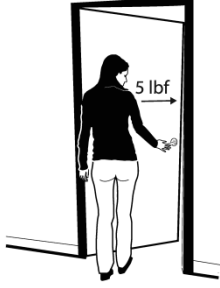
maneuvering clearance level (no steeper than 1:48)? [404.2.4]	Measurement:		Photo #:	
<p><b>3.8</b> If the threshold is vertical is it no more than ¼ inch high?</p> <p>Or</p> <p>No more than ½ inch high with the top ¼ inch beveled no steeper than 1:2, if the threshold was installed on or after the 1991 ADA Standards went into effect (1/26/93)?</p> <p>Or</p> <p>No more than ¾ inch high with the top ½ inch beveled no steeper than 1:2, if the threshold was installed before the 1991 ADA Standards went into effect (1/26/93)? [404.2.5, 303.2]</p> <p>Note: The first ¼ inch of the ½ or ¾ inch threshold may be vertical; the rest must be beveled.</p>	<p><input checked="" type="checkbox"/> Yes <input type="checkbox"/> No Measurement: .25"</p> <p><input type="checkbox"/> Yes <input type="checkbox"/> No Measurement:</p> <p><input type="checkbox"/> Yes <input type="checkbox"/> No Measurement:</p>	 <p>1/4" max →</p> <p>1/2" max →</p> <p>3/4" max →</p>	<p>Photo #:</p> <p>Photo #:</p>	<ul style="list-style-type: none"> <li>• Remove or replace threshold</li> <li>•</li> <li>•</li> </ul>

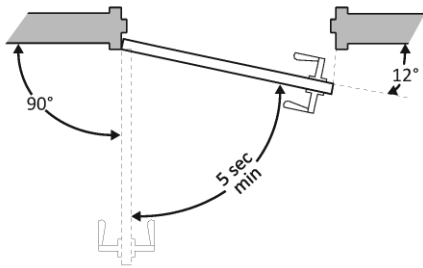
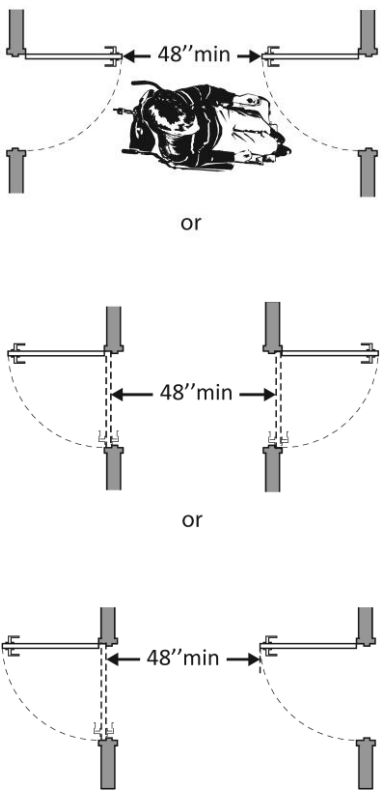
<p><b>3.9</b> Is the door equipped with hardware that is operable with one hand and does not require tight grasping, pinching or twisting of the wrist?</p> <p>Door handle?</p> <p>Lock (if provided)? [404.2.7]</p>	<p><input checked="" type="checkbox"/> Yes <input type="checkbox"/> No</p>		<p>1<sup>ST</sup> PIC</p> <p>Photo #:</p>	<ul style="list-style-type: none"> <li>• Replace inaccessible knob with lever, loop or push hardware</li> <li>• Add automatic door opener</li> <li>•</li> </ul>
<p><b>3.10</b> Are the operable parts of the door hardware mounted no less than 34 inches and no greater than 48 inches above the floor? [404.2.7]</p>	<p><input checked="" type="checkbox"/> Yes <input type="checkbox"/> No</p> <p>Measurement: 39"</p>		<p>Photo #:</p>	<ul style="list-style-type: none"> <li>• Change hardware height</li> <li>•</li> <li>•</li> </ul>
<p><b>3.11</b> Can the door be opened easily (5 pounds maximum force)? [404.2.9]</p> <p>Note: You can use a pressure gauge or fish scale to measure force. If you do not have one you will need to judge whether the door is easy to open.</p>	<p><input checked="" type="checkbox"/> Yes <input type="checkbox"/> No</p> <p>Measurement: 3 LBS</p>		<p>Photo #:</p>	<ul style="list-style-type: none"> <li>• Adjust or replace closers</li> <li>• Install lighter doors</li> <li>• Install power-assisted or automatic door openers</li> </ul>

<p><b>3.12</b> If the door has a closer, does it take at least 5 seconds to close from an open position of 90 degrees to a position of 12 degrees from the latch? [404.2.8.1]</p>	<p><input type="checkbox"/> Yes <input type="checkbox"/> No</p> <p>Measurement: 3 SEC</p>		<p>Photo #:</p>	<ul style="list-style-type: none"> <li>• Adjust closer</li> <li>•</li> <li>•</li> </ul>
<p><b>3.13</b> If there are two doors in a series, e.g. vestibule, is the distance between the doors at least 48 inches plus the width of the doors when swinging into the space? [404.2.6]</p>	<p><input type="checkbox"/> Yes <input type="checkbox"/> No</p> <p>Measurement:</p>		<p>NA</p> <p>Photo #:</p>	<ul style="list-style-type: none"> <li>• Remove inner door</li> <li>• Change door swing</li> <li>•</li> </ul>

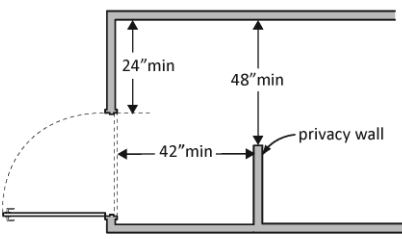
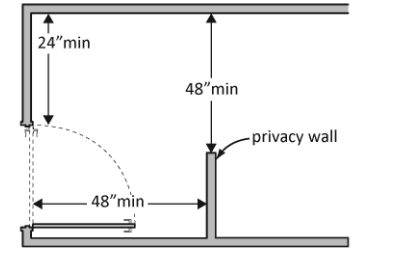

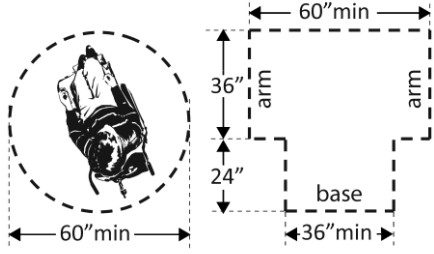
<p><b>3.14</b> If there is a privacy wall and the door swings out, is there at least 24 inches of maneuvering clearance beyond the door latch side and 42 inches to the privacy wall? [404.2.4]</p>	<p><input type="checkbox"/> Yes <input type="checkbox"/> No Measurement:</p>		<p>Photo #:</p>	<ul style="list-style-type: none"> <li>• Reconfigure space</li> <li>•</li> <li>•</li> </ul>
<p><b>3.15</b> If there is a privacy wall and the door swings in, is there at least 24 inches of maneuvering clearance beyond the door latch side and at least 48 inches to the privacy wall if there is no door closer or at least 54 inches if there is a door closer? [404.2.4]</p>	<p><input type="checkbox"/> Yes <input type="checkbox"/> No Measurement:</p>		<p>Photo #:</p>	<ul style="list-style-type: none"> <li>• Reconfigure space</li> <li>•</li> <li>•</li> </ul>
<p><b>In the Toilet Room</b></p>				
<p><b>3.16</b> Is there a clear path to at least one of each type of fixture, e.g. lavatory, hand dryer, etc., that is at least 36 inches wide? [403.5.1]</p>	<p><input checked="" type="checkbox"/> Yes <input type="checkbox"/> No Measurement: 66"</p>		<p>Photo #:</p>	<ul style="list-style-type: none"> <li>• Remove obstructions</li> <li>•</li> <li>•</li> </ul>
<p><b>3.17</b> Is there clear floor space available for a person in a wheelchair to turn around, i.e. a circle at least 60 inches in diameter or a T-shaped space within a 60-inch square? [603.2.1]</p>	<p><input checked="" type="checkbox"/> Yes <input type="checkbox"/> No Measurement: 66"</p>		<p>Photo #:</p>	<ul style="list-style-type: none"> <li>• Move or remove partitions, fixtures or objects such as trash cans</li> <li>•</li> <li>•</li> </ul>

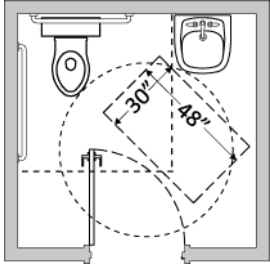
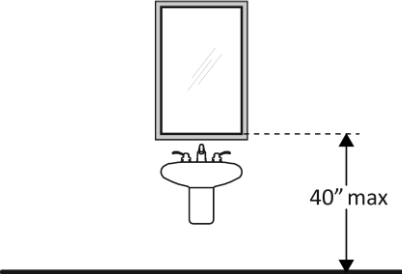
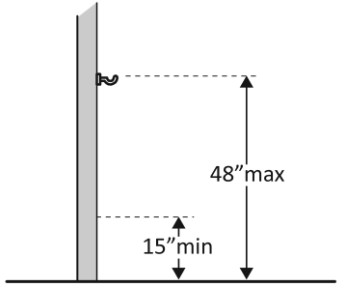
<p><b>3.18</b> In a single user toilet room if the door swings in and over a clear floor space at an accessible fixture, is there a clear floor space at least 30 x 48 inches beyond the swing of the door? [603.2.3 Exception 2]</p>	<p><input type="checkbox"/> Yes <input type="checkbox"/> No</p> <p>Measurement:</p>		<p>NA</p> <p>Photo #:</p>	<ul style="list-style-type: none"> <li>• Reverse door swing</li> <li>• Alter toilet room</li> <li>•</li> </ul>
<p><b>3.19</b> If the mirror is over a lavatory or countertop, is the bottom edge of the reflecting surface no higher than 40 inches above the floor? Or If the mirror is not over the lavatory or countertop, is the bottom edge of the reflecting surface no higher than 35 inches above the floor?*</p>	<p><input type="checkbox"/> Yes <input checked="" type="checkbox"/> No</p> <p>Measurement: 44"</p> <p><input type="checkbox"/> Yes <input type="checkbox"/> No</p> <p>Measurement:</p>		<p>Photo #:</p>	<p>* If installed before 3/15/2012 and the bottom edge of the reflecting surface is no higher than 40 inches above the floor, lowering the mirror to 35 inches is not required</p> <ul style="list-style-type: none"> <li>• Lower the mirror</li> <li>• Add another mirror</li> <li>•</li> </ul>
<p><b>3.20</b> If there is a coat hook, is it no less than 15 inches and no greater than 48 inches above the floor?*</p>	<p><input type="checkbox"/> Yes <input type="checkbox"/> No</p> <p>Measurement:</p>		<p>NA</p> <p>Photo #:</p>	<ul style="list-style-type: none"> <li>• Adjust hook</li> <li>• Replace with or provide additional accessible hook</li> <li>•</li> </ul> <p>* If installed before 3/15/2010 and the clear floor space allows a parallel approach, the coat hook may be 54 inches above the floor.</p>

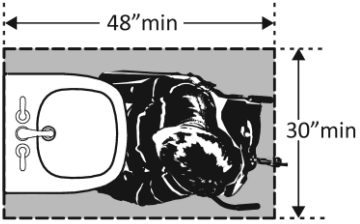
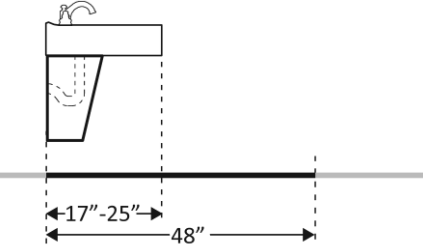
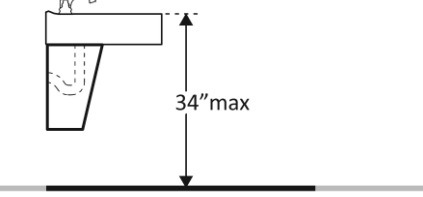
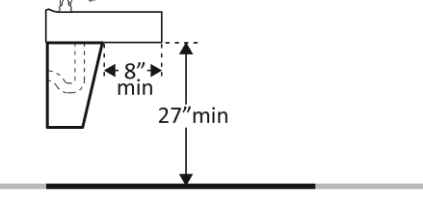
Lavatories The 2010 Standards refer to sinks in toilet rooms as lavatories.				
<p><b>3.21</b> Does at least one lavatory have a clear floor space for a forward approach at least 30 inches wide and 48 inches long? [606.2]</p>	<p><input checked="" type="checkbox"/> Yes <input type="checkbox"/> No Measurement: 66X41"</p>		<p>Photo #:</p>	<ul style="list-style-type: none"> <li>• Alter lavatory</li> <li>• Replace lavatory</li> <li>•</li> </ul>
<p><b>3.22</b> Do no less than 17 inches and no greater than 25 inches of the clear floor space extend under the lavatory so that a person using a wheelchair can get close enough to reach the faucet? [306.2]</p>	<p><input checked="" type="checkbox"/> Yes <input type="checkbox"/> No Measurement: 17.5"</p>		<p>Photo #:</p>	<ul style="list-style-type: none"> <li>• Alter lavatory</li> <li>• Replace lavatory</li> <li>•</li> </ul>
<p><b>3.23</b> Is the front of the lavatory or counter surface, whichever is higher, no more than 34 inches above the floor? [606.3]</p>	<p><input checked="" type="checkbox"/> Yes <input type="checkbox"/> No Measurement: 33.5"</p>		<p>Photo #:</p>	<ul style="list-style-type: none"> <li>• Alter lavatory</li> <li>• Replace lavatory</li> <li>•</li> </ul>
<p><b>3.24</b> Is there at least 27 inches clearance from the floor to the bottom of the lavatory that extends at least 8 inches under the lavatory for knee clearance? [306.3.3]</p>	<p><input checked="" type="checkbox"/> Yes <input type="checkbox"/> No Measurement: 28.5"</p>		<p>Photo #:</p>	<ul style="list-style-type: none"> <li>• Alter lavatory</li> <li>• Replace lavatory</li> <li>•</li> </ul>

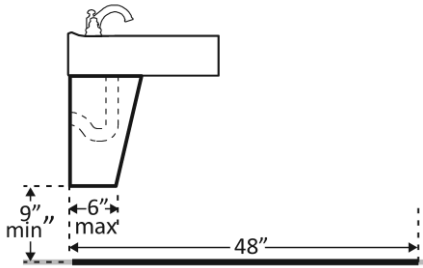
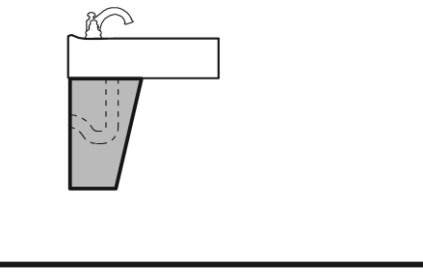
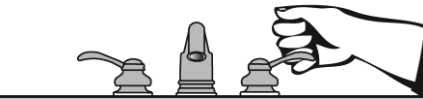
<p><b>3.25</b> Is there toe clearance at least 9 inches high? [306.3.3]</p> <p>Note: Space extending greater than 6 inches beyond the available toe clearance at 9 inches above the floor is not considered toe clearance.</p>	<p><input checked="" type="checkbox"/> Yes <input type="checkbox"/> No</p> <p>Measurement: 15.5"</p>		<p>Photo #:</p>	<ul style="list-style-type: none"> <li>• Alter lavatory</li> <li>• Replace lavatory</li> <li>•</li> </ul>
<p><b>3.26</b> Are pipes below the lavatory insulated or otherwise configured to protect against contact? [606.5]</p>	<p><input type="checkbox"/> Yes <input checked="" type="checkbox"/> No</p>		<p>Photo #:</p>	<ul style="list-style-type: none"> <li>• Install insulation</li> <li>• Install cover panel</li> <li>•</li> </ul>
<p><b>3.27</b> Can the faucet be operated without tight grasping, pinching, or twisting of the wrist?</p> <p>Is the force required to activate the faucet no greater than 5 pounds? [606.4]</p>	<p><input checked="" type="checkbox"/> Yes <input type="checkbox"/> No</p> <p><input type="checkbox"/> Yes <input checked="" type="checkbox"/> No</p>		<p>Photo #:</p>	<ul style="list-style-type: none"> <li>• Adjust faucet</li> <li>• Replace faucet</li> <li>•</li> </ul>

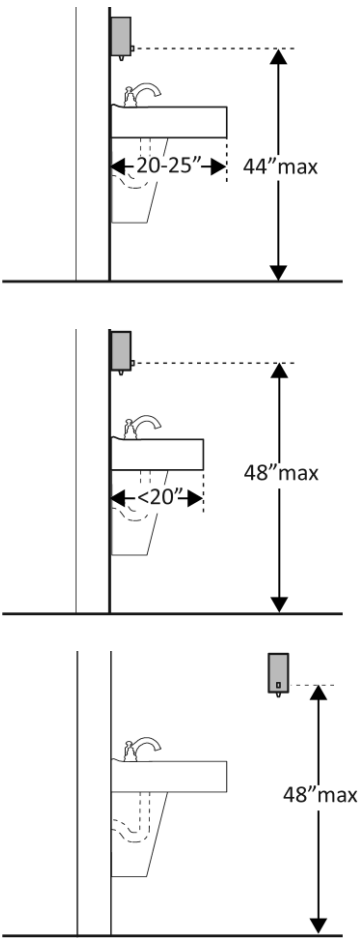
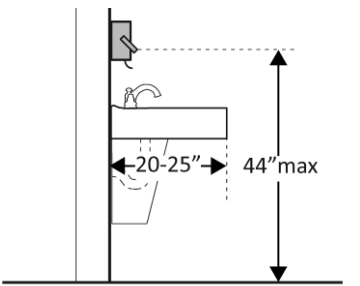
Soap Dispensers and Hand Dryers				
<p><b>3.28</b> Are the operable parts of the soap dispenser within one of the following reach ranges:</p> <p>Above lavatories or counters no less than 20 inches and no greater than 25 inches deep: no higher than 44 inches above the floor? [308.2.2]</p> <p>Above lavatories less than 20 inches deep: no higher than 48 inches above the floor?</p> <p>Not over an obstruction: no higher than 48 inches above the floor? [308.2]</p>	<p><input type="checkbox"/> Yes <input type="checkbox"/> No Measurement:</p> <p><input type="checkbox"/> Yes <input type="checkbox"/> No Measurement:</p> <p><input checked="" type="checkbox"/> Yes <input type="checkbox"/> No Measurement: 42"</p>		<p>Photo #:</p>	<ul style="list-style-type: none"> <li>• Adjust dispensers</li> <li>• Replace with or provide additional accessible dispensers</li> <li>•</li> </ul>
<p><b>3.29</b> Are the operable parts of the hand dryer or towel dispenser within one of the following reach ranges:</p> <p>Above lavatories or counters no less than 20 inches and no greater than 25 inches deep: no higher than 44 inches above the</p>	<p><input type="checkbox"/> Yes <input type="checkbox"/> No Measurement:</p>		<p>Photo #:</p>	<ul style="list-style-type: none"> <li>• Adjust dispensers</li> <li>• Replace with or provide additional accessible dispensers</li> <li>•</li> </ul>

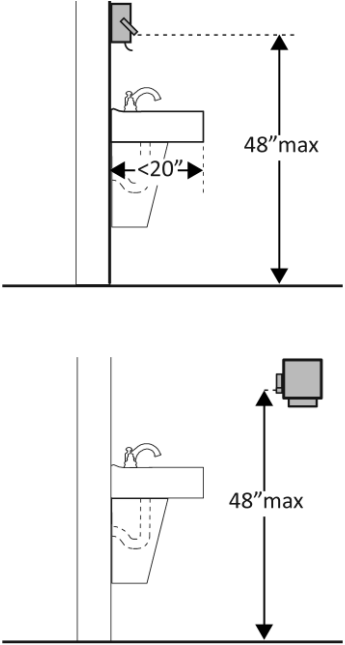
<p>floor?</p> <p>Above lavatories less than 20 inches deep: no higher than 48 inches above the floor?</p> <p>Not over an obstruction: no higher than 48 inches above the floor? [308.2]</p> <p>Can the operable parts of the hand dryer or towel dispenser be operated without tight grasping, pinching or twisting of the wrist?</p> <p>Is the force required to activate the hand dryer or towel dispenser no greater than 5 pounds? [309.4]</p>	<p><input type="checkbox"/> Yes <input type="checkbox"/> No Measurement:</p> <p><input type="checkbox"/> Yes <input type="checkbox"/> No Measurement:</p> <p><input type="checkbox"/> Yes <input checked="" type="checkbox"/> No</p> <p><input checked="" type="checkbox"/> Yes <input type="checkbox"/> No Measurement:</p>		<p>Photo #:</p>	
--	--	--	-----------------	--

**Water Closets in Single-User Toilet Rooms and Compartments (Stalls)** The 2010 Standards refer to toilets as water closets.

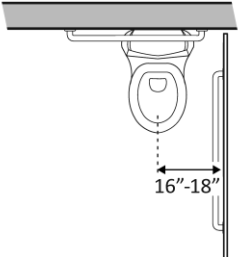
<p><b>3.30</b> Is the centerline of the water closet no less than 16 inches and no greater than 18 inches from the side wall or partition? [604.2]</p>	<p><input checked="" type="checkbox"/> Yes <input type="checkbox"/> No Measurement: 18"</p>		<p>Photo #:</p>	<ul style="list-style-type: none"> <li>• Move toilet</li> <li>• Replace toilet</li> <li>• Move partition</li> <li>•</li> </ul>
--	---	--	-----------------	--

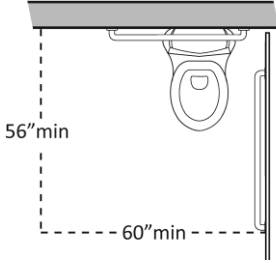
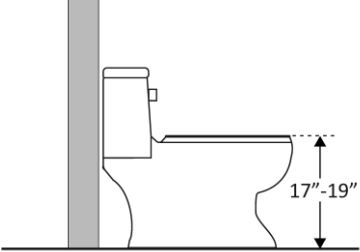
<p><b>3.31</b> Is clearance provided around the water closet measuring at least 60 inches from the side wall and at least 56 inches from the rear wall?*</p> <p>[604.3.1]</p>	<p><input checked="" type="checkbox"/> Yes <input type="checkbox"/> No</p> <p>Measurement: 61X60"</p>		<p>Photo #:</p> <p>* If constructed before 3/15/12, clearances around water closets in single user toilet rooms can be 48 inches wide by 66 inches long or 48 inches wide by 56 inches long (depending on the approach to the water closet, see 1991 Standards Figure 28) and the lavatory may overlap that clearance if the door to the room does not swing into the required clearances at fixtures (such as lavatories, water closet and urinals) and the edge of the lavatory is at least 18 inches from the centerline of the water closet</p> <ul style="list-style-type: none"> <li>• Alter room/compartments for clearance</li> <li>•</li> <li>•</li> </ul>
<p><b>3.32</b> Is the height of the water closet no less than 17 inches and no greater than 19 inches above the floor measured to the top of the seat?</p> <p>[604.4]</p>	<p><input checked="" type="checkbox"/> Yes <input type="checkbox"/> No</p> <p>Measurement: 18"</p>		<p>Photo #:</p> <ul style="list-style-type: none"> <li>• Adjust toilet height</li> <li>• Replace toilet</li> <li>•</li> </ul>

<p><b>3.33</b> Is there a grab bar at least 42 inches long on the side wall?</p> <p>Is it located no more than 12 inches from the rear wall?</p> <p>Does it extend at least 54 inches from the rear wall? [604.5.1]</p> <p>Is it mounted no less than 33 inches and no greater than 36 inches above the floor to the top of the gripping surface? [609.4]</p> <p>Is there at least 12 inches clearance between the grab bar and projecting objects above?*</p> <p>Is there at least 1½ inches clearance between the grab bar and projecting objects below?*</p> <p>Is the space between the wall and the grab bar 1 ½ inches? [609.3]</p>	<p><input checked="" type="checkbox"/> Yes <input type="checkbox"/> No Measurement: 43'</p> <p><input checked="" type="checkbox"/> Yes <input type="checkbox"/> No Measurement: 12"</p> <p><input checked="" type="checkbox"/> Yes <input type="checkbox"/> No Measurement: 54"</p> <p><input checked="" type="checkbox"/> Yes <input type="checkbox"/> No Measurement: 36"</p> <p><input checked="" type="checkbox"/> Yes <input type="checkbox"/> No Measurement: 4"</p> <p><input checked="" type="checkbox"/> Yes <input type="checkbox"/> No Measurement: 1.5"</p>	<p>The diagrams illustrate the following requirements for grab bar installation:</p> <ul style="list-style-type: none"> <li><b>Length:</b> The grab bar must be at least 42 inches long and extend at least 54 inches from the rear wall.</li> <li><b>Distance from Rear Wall:</b> The grab bar must be located no more than 12 inches from the rear wall.</li> <li><b>Height:</b> The grab bar must be mounted between 33 inches and 36 inches above the floor to the top of the gripping surface.</li> <li><b>Clearance Above:</b> There must be at least 12 inches of clearance between the grab bar and any projecting objects above it.</li> <li><b>Clearance Below:</b> There must be at least 1½ inches of clearance between the grab bar and any projecting objects below it.</li> </ul>	<p>Photo #:</p>	<ul style="list-style-type: none"> <li>• Install grab bar</li> <li>• Relocate grab bar</li> <li>• Relocate objects</li> <li>•</li> </ul> <p>* If constructed before 3/15/2012 grab bars do not need to be relocated; there are no space requirements above and below grab bars in the 1991 Standards</p>
---	---	--	-----------------	--



<p><b>3.34</b> Is there a grab bar at least 36 inches long on the rear wall?</p> <p>Does it extend at least 12 inches from the centerline of the water closet on one side (side wall)?</p> <p>Does it extend at least 24 inches on the other (open) side? [604.5.2]</p> <p>Is it mounted no less than 33 inches and no greater than 36 inches above the floor to the top of the gripping surface? [609.4]</p> <p>Are there at least 12 inches clearance between the grab bar and protruding objects above?*</p> <p>Are there at least 1½ inches clearance between the grab bar and projecting objects below?*</p> <p>Is the space between the wall and the grab bar 1½ inches? [609.3]</p>	<p><input checked="" type="checkbox"/> Yes <input type="checkbox"/> No Measurement: 36"</p> <p><input checked="" type="checkbox"/> Yes <input type="checkbox"/> No Measurement: 12"</p> <p><input checked="" type="checkbox"/> Yes <input type="checkbox"/> No Measurement: 24"</p> <p><input checked="" type="checkbox"/> Yes <input type="checkbox"/> No Measurement: 36"</p> <p><input checked="" type="checkbox"/> Yes <input type="checkbox"/> No Measurement: 12"</p> <p><input checked="" type="checkbox"/> Yes <input type="checkbox"/> No Measurement: 3.5"</p> <p><input checked="" type="checkbox"/> Yes <input type="checkbox"/> No Measurement: 1.5"</p>		<p>Photo #:</p>	<ul style="list-style-type: none"> <li>• Install grab bar</li> <li>• Relocate grab bar</li> <li>• Relocate objects</li> <li>•</li> </ul> <p>* If constructed before 3/15/2012 grab bars do not need to be relocated; there are no space requirements above and below grab bars in the 1991 Standards</p>
--	---	--	-----------------	--



<p><b>3.35</b> If the flush control is hand operated, is the operable part located no higher than 48 inches above the floor? [604.6]</p>	<p><input checked="" type="checkbox"/> Yes <input type="checkbox"/> No  Measurement: 28"</p>		<p>Photo #:</p>	<ul style="list-style-type: none"> <li>• Move control</li> <li>• Install sensor with override button no higher than 48 inches</li> <li>•</li> </ul>
<p><b>3.36</b> If the flush control is hand operated, can it be operated with one hand and without tight grasping, pinching, or twisting of the wrist?  Is the force required to activate the flush control no greater than 5 pounds? [605.4]</p>	<p><input checked="" type="checkbox"/> Yes <input type="checkbox"/> No  <input checked="" type="checkbox"/> Yes <input type="checkbox"/> No  Measurement: 2 LBS</p>		<p>Photo #:</p>	<ul style="list-style-type: none"> <li>• Change control</li> <li>• Adjust control</li> <li>•</li> </ul>
<p><b>3.37</b> Is the flush control on the open side of the water closet? [604.6]</p>	<p><input checked="" type="checkbox"/> Yes <input type="checkbox"/> No</p>		<p>Photo #:</p>	<ul style="list-style-type: none"> <li>• Move control</li> <li>•</li> <li>•</li> </ul>
<p><b>3.38</b> Is the toilet paper dispenser located no less than 7 inches and no greater than 9 inches from the front of the water closet to the centerline of the dispenser?*</p>	<p><input checked="" type="checkbox"/> Yes <input type="checkbox"/> No  Measurement: 7"</p>		<p>Photo #:</p>	<p>* If constructed before 3/15/2012 dispenser does not need to be relocated if it is within reach from the water closet seat; the 1991 Standards do not specify distance from the front of the water closet</p>

			Photo #:	<ul style="list-style-type: none"> <li>• Relocate dispenser</li> <li>•</li> <li>•</li> </ul>
<p><b>3.39</b> Is the outlet of the dispenser:</p> <p>Located no less than 15 inches and no greater than 48 inches above the floor?</p> <p>Not located behind grab bars? [604.7]</p>	<p><input checked="" type="checkbox"/> Yes <input type="checkbox"/> No</p> <p>Measurement: 19"</p> <p><input checked="" type="checkbox"/> Yes <input type="checkbox"/> No</p>		Photo #:	<ul style="list-style-type: none"> <li>• Relocate dispenser</li> <li>•</li> <li>•</li> </ul>
<p><b>3.40</b> Does the dispenser allow continuous paper flow? [604.7]</p>	<p><input checked="" type="checkbox"/> Yes <input type="checkbox"/> No</p>		Photo #:	<ul style="list-style-type: none"> <li>• Adjust dispenser</li> <li>• Replace dispenser</li> <li>•</li> </ul>
<b>Toilet Compartments (Stalls)</b>				
<p><b>3.41</b> Is the door opening width at least 32 inches clear, between the face of the door and the stop, when the door is open 90 degrees? [604.8.1.2]</p>	<p><input checked="" type="checkbox"/> Yes <input type="checkbox"/> No</p> <p>Measurement: 34"</p>		Photo #:	<ul style="list-style-type: none"> <li>• Widen door width</li> <li>•</li> <li>•</li> </ul>

<p><b>3.42</b> If there is a front approach to the pull side of the door, is there at least 18 inches of maneuvering clearance beyond the latch side plus 60 inches clear depth? [604.8.1.2]</p> <p>Note: See 2010 Standards 604.8.1.2 Doors for maneuvering clearance requirements on the push side of the door and side approaches to the pull side of the door</p>	<p><input checked="" type="checkbox"/> Yes <input type="checkbox"/> No</p> <p>Measurement: 20"</p>		<p>Photo #:</p>	<ul style="list-style-type: none"> <li>• Remove obstructions</li> <li>•</li> <li>•</li> </ul>
<p><b>3.43</b> Is the door self-closing? [604.8.1.2]</p>	<p><input type="checkbox"/> Yes <input checked="" type="checkbox"/> No</p>		<p>Photo #:</p>	<ul style="list-style-type: none"> <li>• Add closer</li> <li>• Replace door</li> <li>•</li> </ul>
<p><b>3.44</b> Are there door pulls on both sides of the door that are operable with one hand and do not require tight grasping pinching or twisting of the wrist?*</p> <p>[604.8.1.2]</p>	<p><input type="checkbox"/> Yes <input checked="" type="checkbox"/> No</p>		<p>BUILT IN 1998 &gt;</p> <p>Photo #:</p>	<p>* If constructed before 3/15/2012 door pulls do not need to be added; door pulls are not required in the 1991 Standards</p> <ul style="list-style-type: none"> <li>• Replace hardware</li> <li>•</li> <li>•</li> </ul>

<p><b>3.45</b> Is the lock operable with one hand and without tight grasping, pinching or twisting of the wrist? [309.4]</p>	<p><input checked="" type="checkbox"/> Yes <input type="checkbox"/> No</p>		<p>Photo #:</p>	<ul style="list-style-type: none"> <li>• Replace lock</li> <li>•</li> <li>•</li> </ul>
<p><b>3.46</b> Are the operable parts of the door hardware mounted no less than 34 inches and no greater than 48 inches above the floor? [404.2.7]</p>	<p><input checked="" type="checkbox"/> Yes <input type="checkbox"/> No</p> <p>Measurement: 42"</p>		<p>Photo #:</p>	<ul style="list-style-type: none"> <li>• Relocate hardware</li> <li>•</li> <li>•</li> </ul>
<p><b>3.47</b> Is the compartment at least 60 inches wide? [604.8.1.1]</p>	<p><input checked="" type="checkbox"/> Yes <input type="checkbox"/> No</p> <p>Measurement: 60"</p>		<p>Photo #:</p>	<ul style="list-style-type: none"> <li>• Widen compartment</li> <li>•</li> <li>•</li> </ul>
<p><b>3.48</b> If the water closet is wall hung, is the compartment at least 56 inches deep? [604.8.1.1]</p>	<p><input checked="" type="checkbox"/> Yes <input type="checkbox"/> No</p> <p>Measurement: 62"</p>		<p>Photo #:</p>	<ul style="list-style-type: none"> <li>• Widen compartment</li> <li>•</li> <li>•</li> </ul>

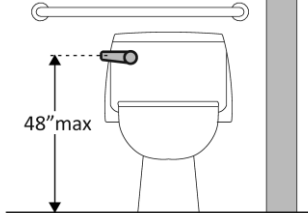
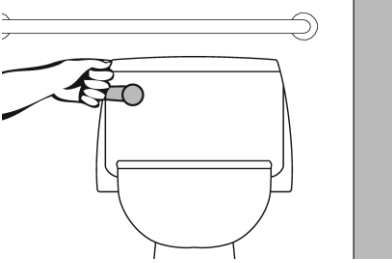
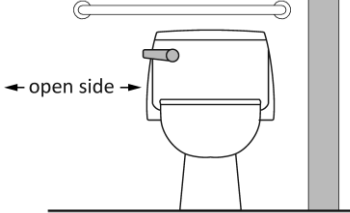
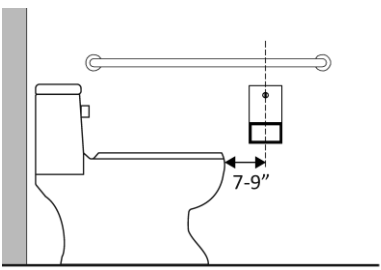
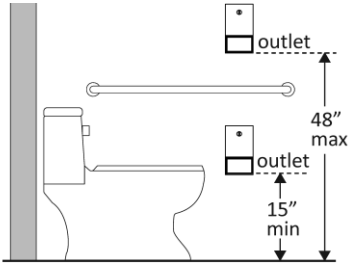
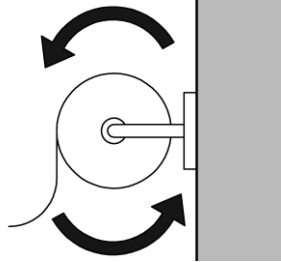
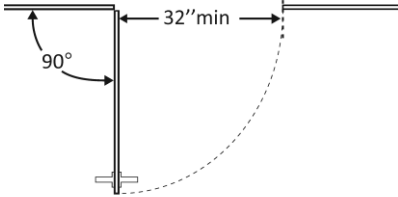
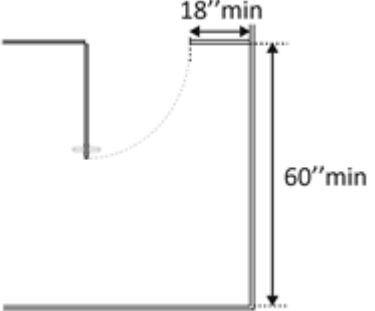
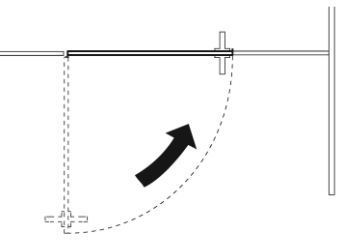
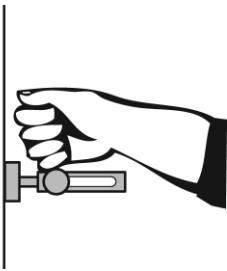
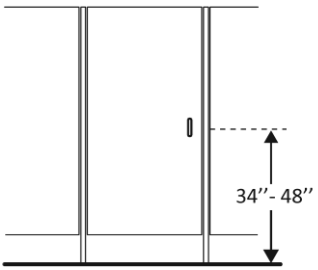
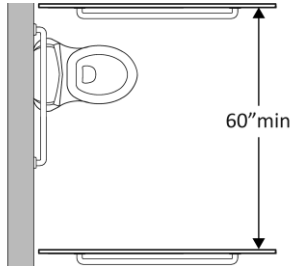
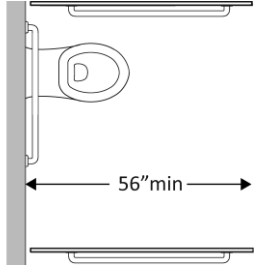
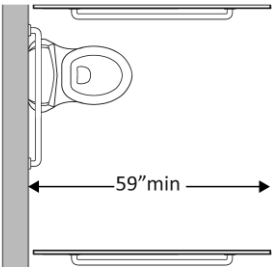
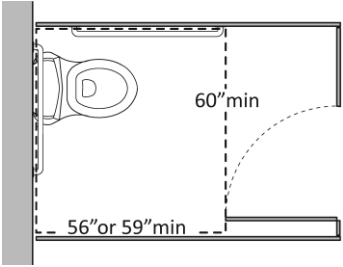
<p><b>3.49</b> If the water closet is floor mounted, is the compartment at least 59 inches deep? [604.8.1.1]</p>	<p><input type="checkbox"/> Yes <input type="checkbox"/> No Measurement:</p>		<p>Photo #:</p>	<ul style="list-style-type: none"> <li>• Alter compartment</li> <li>•</li> <li>•</li> </ul>
<p><b>3.50</b> If the door swings in, is the minimum required compartment area provided beyond the swing of the door (60 inches x 56 inches if water closet is wall hung or 59 inches if water closet is floor mounted)? [604.8.1.1]</p>	<p><input checked="" type="checkbox"/> Yes <input type="checkbox"/> No Measurement: 60X62"</p>		<p>Photo #:</p>	<ul style="list-style-type: none"> <li>• Reverse door swing</li> <li>• Alter compartment</li> <li>•</li> </ul>
	<p><input type="checkbox"/> Yes <input type="checkbox"/> No</p>		<p>Photo #:</p>	<ul style="list-style-type: none"> <li>•</li> <li>•</li> <li>•</li> </ul>
	<p><input type="checkbox"/> Yes <input type="checkbox"/> No</p>		<p>Photo #:</p>	<ul style="list-style-type: none"> <li>•</li> <li>•</li> <li>•</li> </ul>
	<p><input type="checkbox"/> Yes <input type="checkbox"/> No</p>		<p>Photo #:</p>	<ul style="list-style-type: none"> <li>•</li> <li>•</li> <li>•</li> </ul>