

ADA Checklist for Existing Facilities

Priority 2 – Access to Goods & Services

Based on the 2010 ADA Standards for Accessible Design

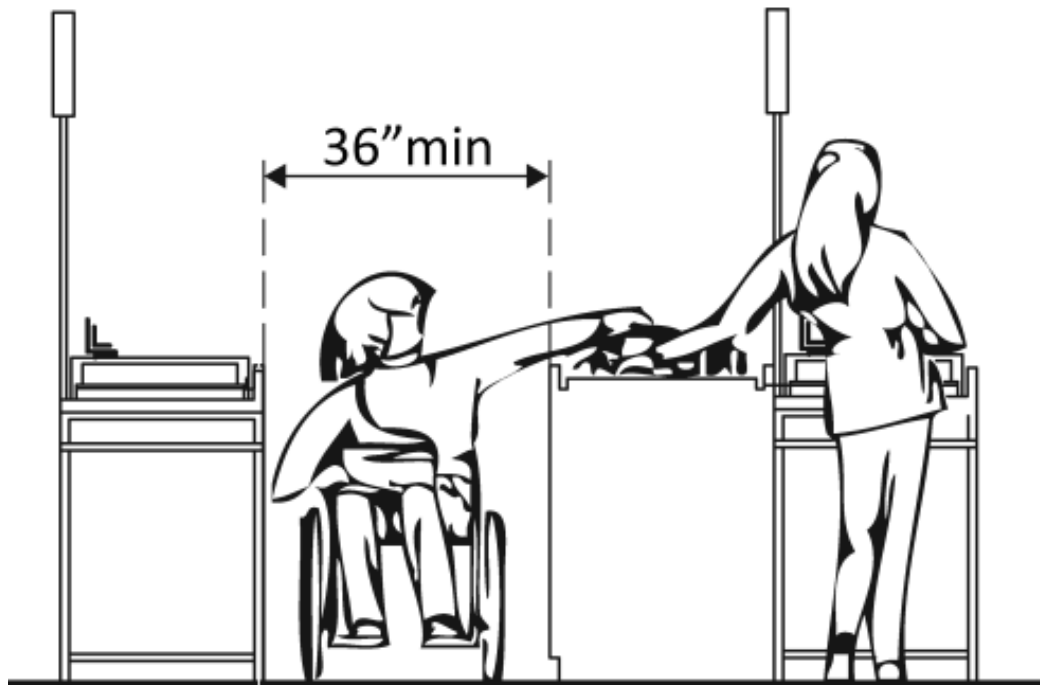

Project

Building ANNEX

Location EXTENSION OFFICE

Date 10/15/2021

Surveyors LARRY WEAVER

SHERI GAILLARD

Contact Information SHERI / 574-242-2508

The layout of the building should allow people with disabilities to obtain goods and services and to participate in activities without assistance.



Institute for Human Centered Design
www.HumanCenteredDesign.org

Copyright © 2016



ADA National Network
Questions on the ADA 800-949-4232 voice/tty
www.ADAchecklist.org



This checklist was produced by the New England ADA Center, a project of the Institute for Human Centered Design and a member of the ADA National Network. This checklist was developed under a grant from the Department of Education, NIDRR grant number H133A060092-09A. However the contents do not necessarily represent the policy of the Department of Education, and you should not assume endorsement by the Federal Government.

Questions or comments on the checklist contact the New England ADA Center at 617-695-0085 voice/tty or ADAinfo@NewEnglandADA.org

For the full set of checklists, including the checklists for recreation facilities visit www.ADAchecklist.org.

Copyright © 2016 ADA Checklist for Existing Materials. You can freely reproduce and distribute this content. Include proper attribution. But you must get permission before using this content as a fee-based product.

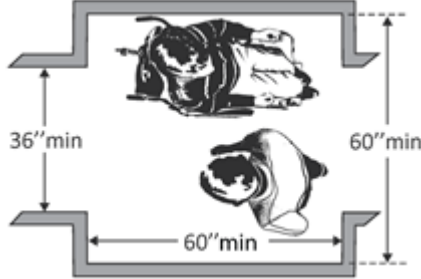
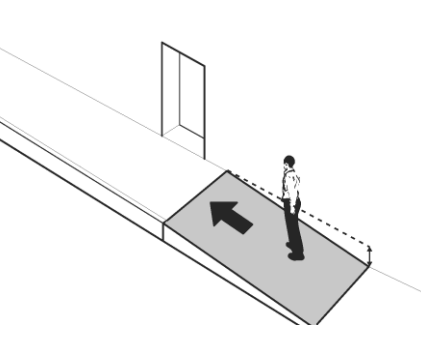
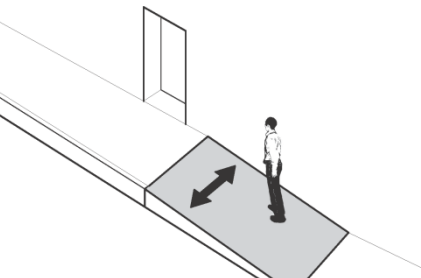
Priority 2 – Access to Goods & Services		Comments	Possible Solutions
<p>2.1 Does the accessible entrance provide direct access to the main floor, lobby and elevator? [See 2010 ADA Standards for Accessible Design – 206.4]</p>	<input checked="" type="checkbox"/> Yes <input type="checkbox"/> No	<p>Photo #:</p>	<ul style="list-style-type: none"> • Create accessible route • •
Interior Accessible Route			
<p>2.2 Are all public spaces on at least one accessible route? [206.2.4]</p>	<input checked="" type="checkbox"/> Yes <input type="checkbox"/> No	<p>Photo #:</p>	<ul style="list-style-type: none"> • Create accessible route • •
<p>2.3 Is the route stable, firm and slip-resistant? [40.2, 302.1]</p>	<input checked="" type="checkbox"/> Yes <input type="checkbox"/> No	<p>Photo #:</p>	<ul style="list-style-type: none"> • Repair uneven surfaces • •
<p>2.4 Is the route at least 36 inches wide? [403.5.1]</p> <p>Note: The accessible route can narrow to 32 inches min. for a max. of 24 inches. These narrower portions of the route must be at least 48 inches from each other.</p>	<input checked="" type="checkbox"/> Yes <input type="checkbox"/> No Measurement: 44"	<p>36" min</p> <p>←24" max→ 48" min →24" max←</p> <p>32" min 32" min</p>	<p>Photo #:</p> <ul style="list-style-type: none"> • Widen route • •

<p>2.5 If the route is greater than 200 feet in length and less than 60 inches wide, is there a passing space no less than 60 x 60 inches? [403.5.3]</p>	<p><input type="checkbox"/> Yes <input type="checkbox"/> No</p> <p>Measurement:</p>		<p>NA</p> <p>Photo #:</p>	<ul style="list-style-type: none"> • Widen route for passing space • •
<p>2.6 Is the running slope no steeper than 1:20, i.e. for every inch of height change there are at least 20 inches of route run? [403.3]</p> <p>Note: If the running slope is steeper than 1:20, treat as a ramp and add features such as edge protection and handrails.</p>	<p><input type="checkbox"/> Yes <input type="checkbox"/> No</p> <p>Measurement:</p>		<p>NA</p> <p>Photo #:</p>	<ul style="list-style-type: none"> • Regrade • •
<p>2.7 Is the cross slope no steeper than 1:48? [403.3]</p>	<p><input type="checkbox"/> Yes <input type="checkbox"/> No</p> <p>Measurement:</p>		<p>NA</p> <p>Photo #:</p>	<ul style="list-style-type: none"> • Regrade • •
<p>2.8 Do all objects on circulation paths through public areas, e.g. fire extinguishers, drinking fountains, signs, etc., protrude no more than 4 inches into the path? Or</p>	<p><input checked="" type="checkbox"/> Yes <input type="checkbox"/> No</p> <p>Measurement: 3"</p>	 <p>Or</p>	<p>NA</p> <p>Photo #:</p>	<ul style="list-style-type: none"> • Remove object • Add tactile warning such as permanent planter or partial walls •

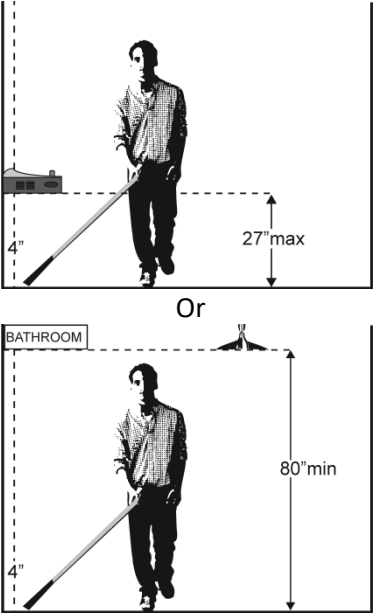
<p>If an object protrudes more than 4 inches, is the bottom leading edge at 27 inches or lower above the floor? [307.2]</p> <p>Or</p> <p>Is the bottom leading edge at 80 inches or higher above the floor? [307.4]</p>	<p><input type="checkbox"/> Yes <input type="checkbox"/> No</p> <p>Measurement:</p> <p><input type="checkbox"/> Yes <input type="checkbox"/> No</p> <p>Measurement:</p>		<p>Photo #:</p>	
<p>2.9 Are there elevators or platform lifts to all public stories?</p> <p>Note: Vertical access is not required in new construction or alterations if a facility is less than three stories or has less than 3,000 square feet per story, unless the facility is a shopping center, shopping mall, professional office of a health care provider, transportation terminal, state facility or local government facility</p>	<p><input checked="" type="checkbox"/> Yes <input type="checkbox"/> No</p>		<p>Photo #:</p>	<ul style="list-style-type: none"> • Install if necessary • Offer goods and services on an accessible story •

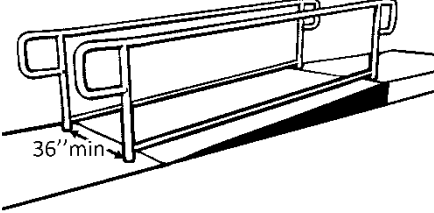
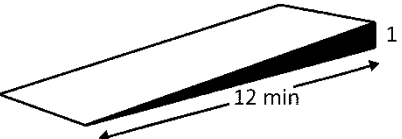
Ramps				
<p>2.10 If there is a ramp, is it at least 36 inches wide? [405.5]</p> <p>Note: If there are handrails, measure between the handrails.</p>	<p><input type="checkbox"/> Yes <input type="checkbox"/> No</p> <p>Measurement:</p>		<p>NA</p> <p>Photo #:</p>	<ul style="list-style-type: none"> • Alter ramp • •
<p>2.11 Is the surface stable, firm and slip resistant? [405.4]</p>	<p><input type="checkbox"/> Yes <input type="checkbox"/> No</p>		<p>NA</p> <p>Photo #:</p>	<ul style="list-style-type: none"> • Resurface ramp • •
<p>2.12 For each section of the ramp, is the running slope no greater than 1:12, i.e. for every inch of height change there are at least 12 inches of ramp run? [405.2]</p> <p>Note: Rises no greater than 3 inches with a slope no steeper than 1:8 and rises no greater than 6 inches with a slope no steeper than 1:10 are permitted when due to space limitations.</p>	<p><input type="checkbox"/> Yes <input type="checkbox"/> No</p> <p>Measurement:</p>		<p>NA</p> <p>Photo #:</p>	<ul style="list-style-type: none"> • Lengthen ramp to decrease slope • Relocate ramp •

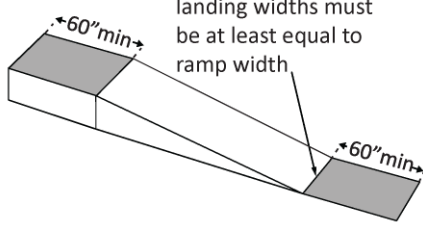
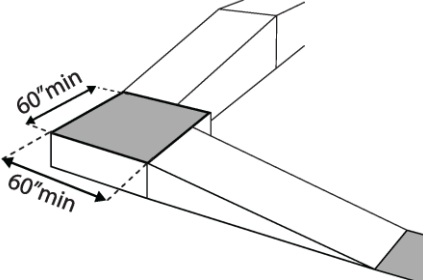
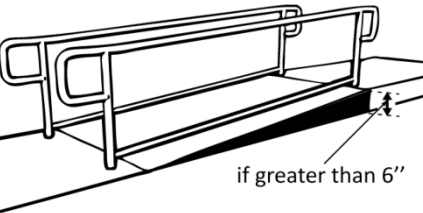
<p>2.13 Is there a level landing that is at least 60 inches long and at least as wide as the ramp:</p> <p>At the top of the ramp?</p> <p>At the bottom of the ramp? [405.7.2, 405.7.3]</p>	<p><input type="checkbox"/> Yes <input type="checkbox"/> No</p> <p>Measurement:</p> <p><input type="checkbox"/> Yes <input type="checkbox"/> No</p> <p>Measurement:</p>		<p>Photo #:</p>	<ul style="list-style-type: none"> • Alter ramp • Relocate ramp •
<p>2.14 Is there a level landing where the ramp changes direction that is at least 60 x 60 inches? [405.7.4]</p>	<p><input type="checkbox"/> Yes <input type="checkbox"/> No</p> <p>Measurement:</p>		<p>NA</p> <p>Photo #:</p>	<ul style="list-style-type: none"> • Increase landing size • •
<p>2.15 If the ramp has a rise higher than 6 inches are there handrails on both sides? [405.8]</p>	<p><input type="checkbox"/> Yes <input type="checkbox"/> No</p> <p>Measurement:</p>		<p>NA</p> <p>Photo #:</p>	<ul style="list-style-type: none"> • Add handrails • •

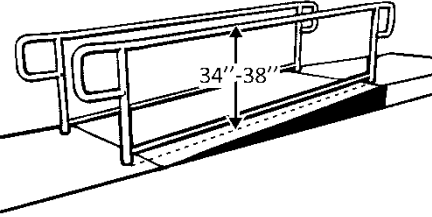
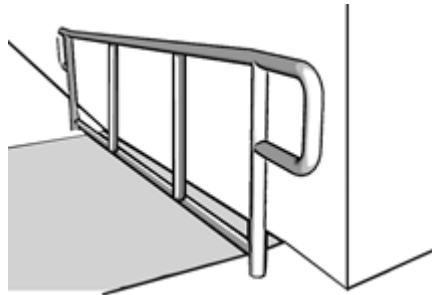
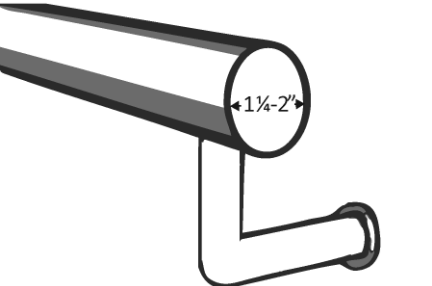
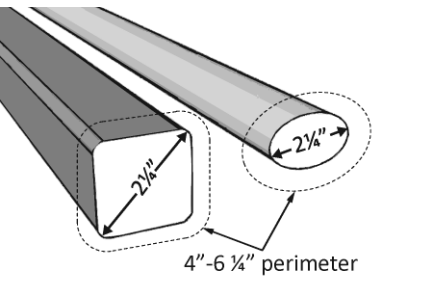
<p>2.16 Is the top of the handrail gripping surface no less than 34 inches and no greater than 38 inches above the ramp surface? [505.4]</p>	<p><input type="checkbox"/> Yes <input type="checkbox"/> No</p> <p>Measurement:</p>		<p>NA</p> <p>Photo #:</p>	<ul style="list-style-type: none"> • Adjust handrail height • •
<p>2.17 Is the handrail gripping surface continuous and not obstructed along the top or sides? [505.3]</p> <p>If there are obstructions, is the bottom of the gripping surface obstructed no more than 20%? [505.6]</p>	<p><input type="checkbox"/> Yes <input type="checkbox"/> No</p> <p><input type="checkbox"/> Yes <input type="checkbox"/> No</p> <p>Measurement:</p>		<p>NA</p> <p>Photo #:</p>	<ul style="list-style-type: none"> • Reconfigure or replace handrails • •
<p>2.18 If the handrail gripping surface is circular, is it no less than 1 ¼ inches and no greater than 2 inches in diameter? [505.7.1]</p>	<p><input type="checkbox"/> Yes <input type="checkbox"/> No</p> <p>Measurement:</p>		<p>NA</p> <p>Photo #:</p>	<ul style="list-style-type: none"> • Replace handrails • •
<p>2.19 If the handrail gripping surface is non-circular:</p> <p>Is the perimeter no less than 4 inches and no greater than 6 ¼ inches?</p>	<p><input type="checkbox"/> Yes <input type="checkbox"/> No</p> <p>Measurement:</p>		<p>NA</p> <p>Photo #:</p>	<ul style="list-style-type: none"> • Replace handrails • •

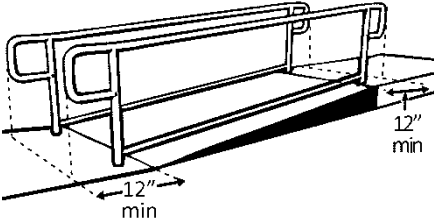
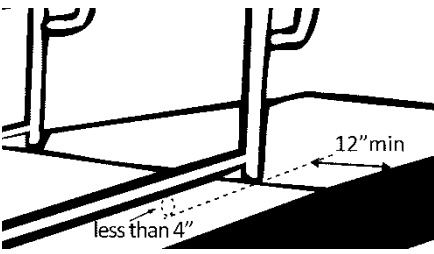
<p>Is the cross section no greater than 2¼ inches? [505.7.2]</p>	<p><input type="checkbox"/> Yes <input type="checkbox"/> No Measurement:</p>		<p>Photo #:</p>	
<p>2.20 Does the handrail:</p> <p>Extend at least 12 inches horizontally beyond the top and bottom of the ramp?</p> <p>Return to a wall, guard, or landing surface? [505.10.1]</p> <p>Note: If a 12" extension would be hazardous (in circulation path), it is not required.</p>	<p><input type="checkbox"/> Yes <input type="checkbox"/> No Measurement:</p> <p><input type="checkbox"/> Yes <input type="checkbox"/> No Measurement:</p>		<p>NA</p> <p>Photo #:</p>	<ul style="list-style-type: none"> • Alter handrails • •
<p>2.21 To prevent wheelchair casters and crutch tips from falling off:</p> <p>Does the surface of the ramp extend at least 12 inches beyond the inside face of the handrail? Or Is there a curb or barrier that prevents the passage of a 4-inch diameter sphere? [405.9.1, 405.9.2]</p>	<p><input type="checkbox"/> Yes <input type="checkbox"/> No Measurement:</p> <p><input type="checkbox"/> Yes <input type="checkbox"/> No Measurement:</p>		<p>NA</p> <p>Photo #:</p>	<ul style="list-style-type: none"> • Add curb • Add barrier • Extend ramp width • •

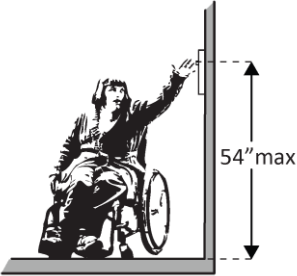
Elevators – Full Size & LULA (limited use, limited application) LULA elevators are often used in alterations.				
<p>2.22 If there is a full size or LULA elevator, are the call buttons no higher than 54 inches above the floor? [407.2.1.1]</p>	<p><input checked="" type="checkbox"/> Yes <input type="checkbox"/> No Measurement: 40"</p>		<p>Photo #:</p>	<ul style="list-style-type: none"> • Change call button height • •
<p>2.23 If there is a full size or LULA elevator, does the sliding door reopen automatically when obstructed by an object or person?*</p>	<p><input type="checkbox"/> Yes <input checked="" type="checkbox"/> No</p>		<p>NO AUTOMATIC SLIDING DOOR</p> <p>Photo #:</p>	<p>* If constructed before 3/15/2012 and manually operated, the door is not required to reopen automatically</p> <ul style="list-style-type: none"> • Install opener •
<p>2.24 If there is a LULA elevator with a swinging door:</p> <p>Is the door power-operated?</p> <p>Does the door remain open for at least 20 seconds when activated?</p>	<p><input type="checkbox"/> Yes <input checked="" type="checkbox"/> No</p> <p><input type="checkbox"/> Yes <input checked="" type="checkbox"/> No</p> <p>Time: 5 SEC</p>		<p>Photo #:</p>	<ul style="list-style-type: none"> • Add power operated door • Adjust opening time •

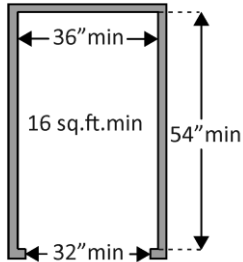
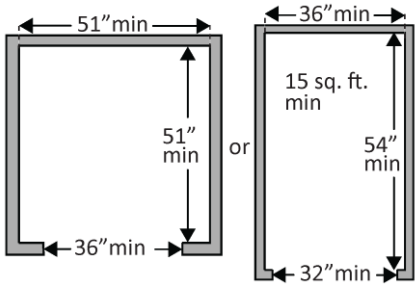
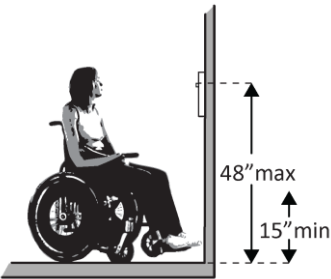
<p>2.25 If there is a full size elevator:</p> <p>Is the interior at least 54 inches deep by at least 36 inches wide with at least 16 sq. ft. of clear floor area?</p> <p>Is the door opening width at least 32 inches? [407.4.1 Exception]</p>	<p><input type="checkbox"/> Yes <input type="checkbox"/> No</p> <p>Measurement:</p> <p><input type="checkbox"/> Yes <input type="checkbox"/> No</p> <p>Measurement:</p>		<p>Photo #:</p>	<ul style="list-style-type: none"> • Replace elevator • •
<p>2.26 If there is a LULA elevator, is the interior:</p> <p>At least 51 inches deep by 51 inches wide with a door opening width of at least 36 inches?</p> <p>Or</p> <p>At least 54 inches deep by at least 36 inches wide with at least 15 sq. ft. of clear floor area and a door opening width of at least 32 inches? [408.4.1 Exceptions 1 and 2]</p>	<p><input type="checkbox"/> Yes <input checked="" type="checkbox"/> No</p> <p>Measurement: 51X32.25"</p> <p><input type="checkbox"/> Yes <input type="checkbox"/> No</p> <p>Measurement:</p>		<p>Photo #:</p>	<ul style="list-style-type: none"> • Replace elevator • •
<p>2.27 If there is a full size or LULA elevator, are the in-car controls:</p> <p>No less than 15 inches and no greater 48 inches above the floor?</p> <p>Or</p>	<p><input type="checkbox"/> Yes <input checked="" type="checkbox"/> No</p> <p>Measurement:</p>	 <p>Or</p>	<p>UNABLE TO BE USED BY SUBJECT IN A WHEELCHAIR</p>	<ul style="list-style-type: none"> • Change control height • •

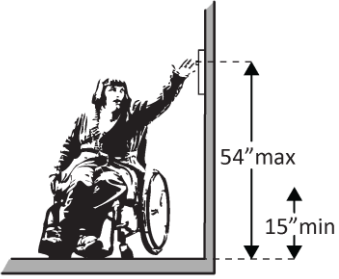
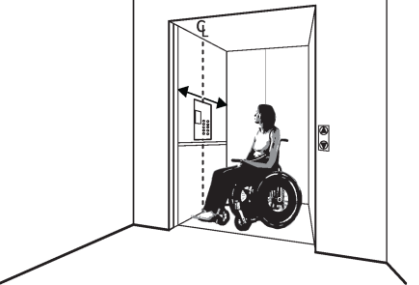
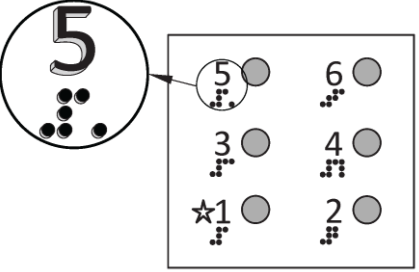
<p>Up to 54 inches above the floor for a parallel approach? [408.4.6, 407.4.6.1]</p>	<p><input type="checkbox"/> Yes <input type="checkbox"/> No Measurement:</p>		<p>Photo #:</p>	
<p>2.28 If there is a LULA elevator, are the in-car controls centered on a side wall? [408.4.6]</p>	<p><input checked="" type="checkbox"/> Yes <input type="checkbox"/> No Measurement:</p>		<p>Photo #:</p>	<ul style="list-style-type: none"> • Reconfigure controls • •
<p>2.29 If there is a full size or LULA elevator:</p> <p>Are the car control buttons designated with raised characters?</p> <p>Are the car control buttons designated with Braille?</p> <p>[407.4.7.1, 703.2]</p>	<p><input type="checkbox"/> Yes <input checked="" type="checkbox"/> No</p> <p><input type="checkbox"/> Yes <input checked="" type="checkbox"/> No</p>		<p>Photo #:</p>	<ul style="list-style-type: none"> • Add raised characters • Add Braille •
<p>2.30 If there is a full size elevator, are there audible signals which sound as the car passes or is about to stop at a floor? [407.4.8]</p>	<p><input type="checkbox"/> Yes <input type="checkbox"/> No</p>		<p>NA</p> <p>Photo #:</p>	<ul style="list-style-type: none"> • Install audible signals • •

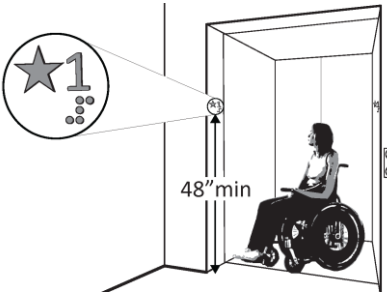
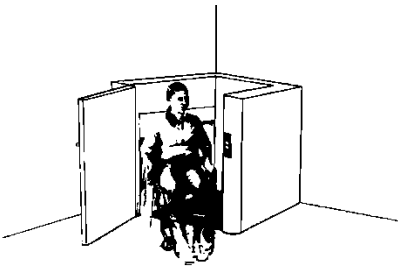
<p>2.31 If there is a full size or LULA elevator:</p> <p>Is there a sign on both door jambs at every floor identifying the floor?</p> <p>Is there a tactile star on both jambs at the main entry level?</p> <p>Do text characters contrast with their backgrounds?</p> <p>Are text characters raised?</p> <p>Is there Braille?</p> <p>Is the sign mounted between 48 inches to the baseline of the lowest character and 60 inches to the baseline of the highest character above the floor?*</p> <p>[407.2.3, 408.2.3]</p>	<p><input type="checkbox"/> Yes <input checked="" type="checkbox"/> No</p> <p><input type="checkbox"/> Yes <input checked="" type="checkbox"/> No</p> <p><input type="checkbox"/> Yes <input checked="" type="checkbox"/> No</p> <p><input type="checkbox"/> Yes <input checked="" type="checkbox"/> No</p> <p><input type="checkbox"/> Yes <input checked="" type="checkbox"/> No</p> <p><input type="checkbox"/> Yes <input checked="" type="checkbox"/> No</p> <p>Measurement:</p>		<p>Photo #:</p>	<ul style="list-style-type: none"> • Install signs • Change sign height • • <p>* If constructed before 3/15/2012 and mounted no higher than 60 inches to the centerline of the sign, relocation is not required</p>
<p>Platform Lifts</p>				
<p>2.32 If a lift is provided, can it be used without assistance from others?</p> <p>[410.1]</p>	<p><input type="checkbox"/> Yes <input checked="" type="checkbox"/> No</p>		<p>Photo #:</p>	<ul style="list-style-type: none"> • Reconfigure so independently operable • •

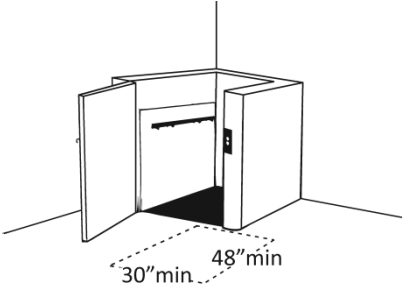
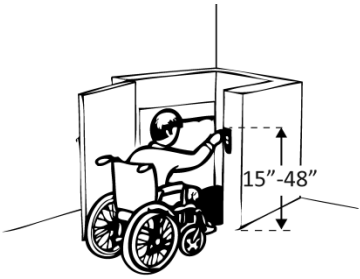
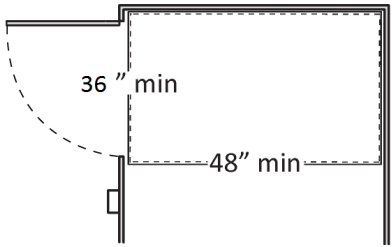
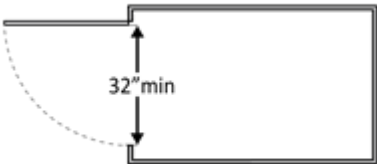
<p>2.33 Is there a clear floor space at least 30 inches wide by at least 48 inches long for a person using a wheelchair to approach and reach the controls to use the lift? [410.5]</p>	<p><input checked="" type="checkbox"/> Yes <input type="checkbox"/> No</p> <p>Measurement: 56X52"</p>		<p>Photo #:</p>	<ul style="list-style-type: none"> • Remove obstructions • •
<p>2.34 Are the lift controls no less than 15 inches and no greater than 48 inches above the floor? [410.5]</p>	<p><input checked="" type="checkbox"/> Yes <input type="checkbox"/> No</p> <p>Measurement: 36"</p>		<p>Photo #:</p>	<ul style="list-style-type: none"> • Change control height • •
<p>2.35 Is there a clear floor space at least 36 inches wide by at least 48 inches long inside the lift? [410.3]</p>	<p><input type="checkbox"/> Yes <input checked="" type="checkbox"/> No</p> <p>Measurement: 32.5X50"</p>		<p>Photo #:</p>	<ul style="list-style-type: none"> • Replace lift • •
<p>2.36 If there is an end door, is the clear opening width at least 32 inches? [410.6]</p>	<p><input checked="" type="checkbox"/> Yes <input type="checkbox"/> No</p> <p>Measurement: 33"</p>		<p>Photo #:</p>	<ul style="list-style-type: none"> • Alter door width • •

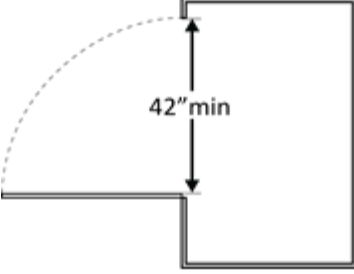
<p>2.37 If there is a side door, is the clear opening width at least 42 inches? [410.6]</p>	<p><input type="checkbox"/> Yes <input type="checkbox"/> No</p> <p>Measurement:</p>		<p>NA</p> <p>Photo #:</p>	<ul style="list-style-type: none"> • Alter door width • •
--	---	--	---------------------------	--

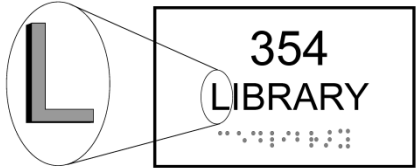
<p>Signs “Tactile characters” are read using touch, i.e. raised characters and Braille.</p>				
<p>2.38 If there are signs designating permanent rooms and spaces not likely to change over time, e.g. room numbers and letters, room names, and exit signs: [216.2]</p> <p>Do text characters contrast with their backgrounds? [703.5]</p> <p>Are text characters raised? [703.2]</p> <p>Is there Braille? [703.3]</p> <p>Is the sign mounted: On the wall on the latch side of the door? [703.4.2]</p> <p>Note: Signs are permitted on the push side of doors with</p>	<p><input type="checkbox"/> Yes <input checked="" type="checkbox"/> No</p> <p><input type="checkbox"/> Yes <input checked="" type="checkbox"/> No</p> <p><input type="checkbox"/> Yes <input checked="" type="checkbox"/> No</p> <p><input type="checkbox"/> Yes <input checked="" type="checkbox"/> No</p>		<p>NO SIGNS</p>	<ul style="list-style-type: none"> • Install tactile sign • Relocate sign •

closers and without hold-open devices.

With clear floor space beyond the arc of the door swing between the closed position and 45-degree open position, at least 18 x 18 inches centered on the tactile characters? * [703.4.2]

Yes No

Measurement: "

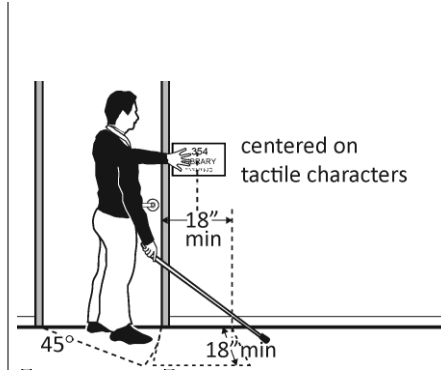

So the baseline of the lowest character is at least 48 inches above the floor and the baseline of the highest character is no more than 60 inches above the floor? * [703.4.1]

Yes No

Measurement: "

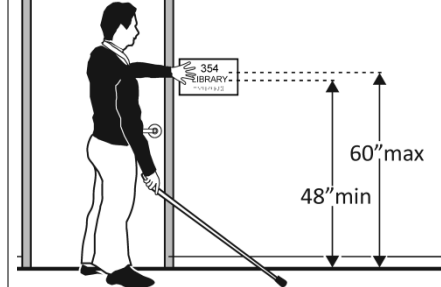

Note: If the sign is at double doors with one active leaf, the sign should be on the inactive leaf; if both leaves are active, the sign should be on the wall to the right of the right leaf.

Photo #:

*If constructed before 3/15/2012 and a person may approach within 3 inches of the sign without encountering protruding objects or standing within the door swing, relocation not required

*If constructed before 3/15/2012 and mounted no higher than 60 inches to the centerline of the sign, relocation not required

2.39 If there are signs that provide direction to or information about interior spaces:

Do text characters contrast with their backgrounds? [703.5.1]

Yes No

Is the sign mounted so that characters are at least 40 inches above the floor? [703.5.6]

Yes No

Measurement:

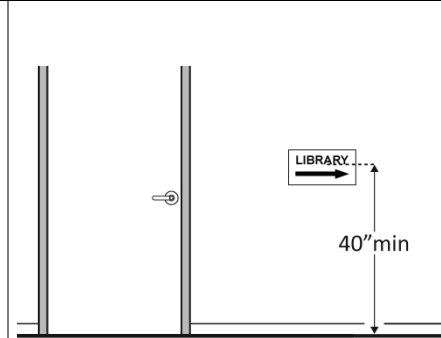

- Install signs with contrasting characters
- Change sign height
-

<p>Note: Raised characters and Braille are not required.</p>			<p>Photo #:</p>	
--	--	--	-----------------	--

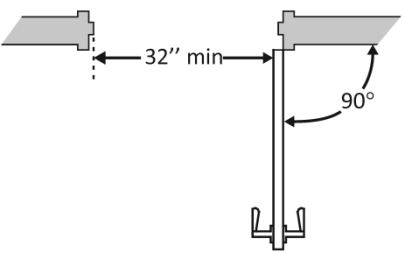
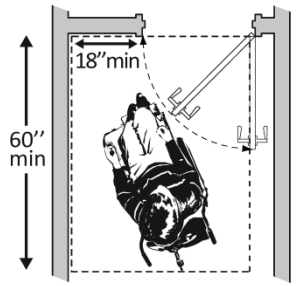
<p>Interior Doors – to classrooms, medical exam rooms, conference rooms, etc.</p>				
<p>2.40 Is the door opening width at least 32 inches clear, between the face of the door and the stop, when the door is open 90 degrees? [404.2.3]</p>	<p><input checked="" type="checkbox"/> Yes <input type="checkbox"/> No</p> <p>Measurement: 32"</p>	 <p>The diagram shows a side view of a door frame. The door is swung open to a 90-degree angle. A horizontal dimension line indicates a minimum clear width of 32 inches between the door's face and the stop on the opposite side.</p>	<p>Photo #:</p>	<ul style="list-style-type: none"> • Install offset hinges • Alter the doorway •
<p>2.41 If there is a front approach to the pull side of the door, is there at least 18 inches of maneuvering clearance beyond the latch side plus at least 60 inches clear depth?</p> <p>Note: See 2010 Standards 404.2.4 for maneuvering clearance requirements on the push side of the door and side approaches to the pull side of the door.</p>	<p><input type="checkbox"/> Yes <input checked="" type="checkbox"/> No</p> <p>Measurement: 12"</p>	 <p>The diagram shows a top-down view of a wheelchair approaching a door. A dashed line indicates a 18-inch minimum maneuvering clearance beyond the door's latch side. A vertical dimension line indicates a 60-inch minimum clear depth for the approach.</p>	<p>Photo #:</p>	<ul style="list-style-type: none"> • Remove obstructions • Reconfigure walls • Add automatic door opener

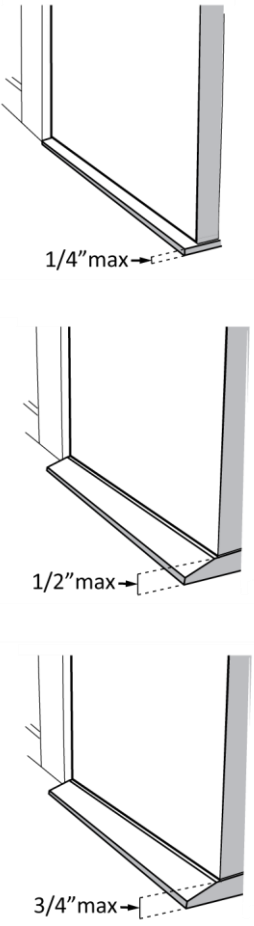
<p>On both sides of the door, is the floor surface of the maneuvering clearance level (no steeper than 1:48)? [404.2.4]</p>	<p><input checked="" type="checkbox"/> Yes <input type="checkbox"/> No</p> <p>Measurement: LEVEL</p>		<p>Photo #:</p>	
<p>2.42 If the threshold is vertical is it no more than ¼ inch high?</p> <p>Or</p> <p>No more than ½ inch high with the top ¼ inch beveled no steeper than 1:2, if the threshold was installed on or after the 1991 ADA Standards went into effect (1/26/93)?</p> <p>Or</p> <p>No more than ¾ inch high with the top ½ inch beveled no steeper than 1:2, if the threshold was installed before the 1991 ADA Standards went into effect (1/26/93)? [404.2.5, 303.2]</p> <p>Note: The first ¼ inch of the ½ or ¾ inch threshold may be vertical; the rest must be beveled.</p>	<p><input checked="" type="checkbox"/> Yes <input type="checkbox"/> No</p> <p>Measurement: 1/8"</p> <p><input type="checkbox"/> Yes <input type="checkbox"/> No</p> <p>Measurement:</p> <p><input type="checkbox"/> Yes <input type="checkbox"/> No</p> <p>Measurement:</p>	 <p>1/4" max →</p> <p>1/2" max →</p> <p>3/4" max →</p>	<p>Photo #:</p>	<ul style="list-style-type: none"> • Remove or replace threshold • •

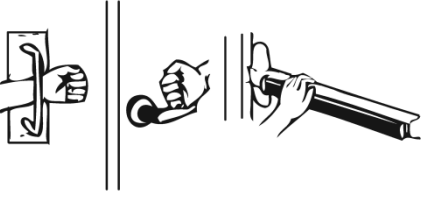
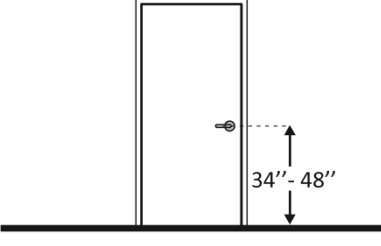
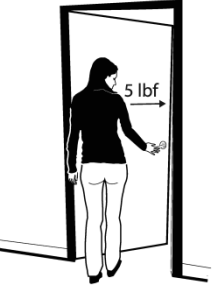
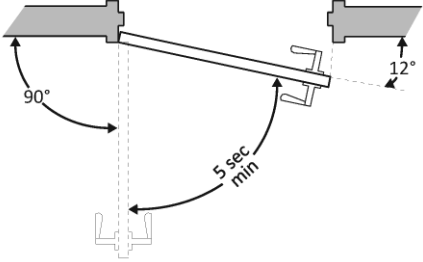
<p>2.43 Is the door equipped with hardware that is operable with one hand and does not require tight grasping, pinching or twisting of the wrist?</p> <p>Door handle?</p> <p>Lock (if provided)? [404.2.7]</p>	<p><input checked="" type="checkbox"/> Yes <input type="checkbox"/> No</p> <p><input checked="" type="checkbox"/> Yes <input type="checkbox"/> No</p> <p><input type="checkbox"/> Yes <input type="checkbox"/> No</p>		<p>1ST PIC</p> <p>Photo #:</p>	<ul style="list-style-type: none"> • Replace inaccessible knob with lever, loop or push hardware • Add automatic door opener •
<p>2.44 Are the operable parts of the hardware no less than 34 inches and no greater than 48 inches above the floor? [404.2.7]</p>	<p><input checked="" type="checkbox"/> Yes <input type="checkbox"/> No</p> <p>Measurement: 43"</p>		<p>Photo #:</p>	<ul style="list-style-type: none"> • Change hardware height • •
<p>2.45 Can the door be opened easily (5 pounds maximum force)? [404.2.9]</p> <p>Note: You can use a pressure gauge or fish scale to measure force. If you do not have one you will need to judge whether the door is easy to open.</p>	<p><input checked="" type="checkbox"/> Yes <input type="checkbox"/> No</p> <p>Measurement: 1.5 LBS</p>		<p>Photo #:</p>	<ul style="list-style-type: none"> • Adjust or replace closers • Install lighter doors • Install power-assisted or automatic door openers
<p>2.46 If the door has a closer, does it take at least 5 seconds to close from an open position of 90 degrees to a position of 12 degrees from the latch? [404.2.8.1]</p>	<p><input type="checkbox"/> Yes <input checked="" type="checkbox"/> No</p> <p>Measurement: 3 SEC</p>		<p>Photo #:</p>	<ul style="list-style-type: none"> • Adjust closer • •

Rooms and Spaces – stores, supermarkets, libraries, etc.

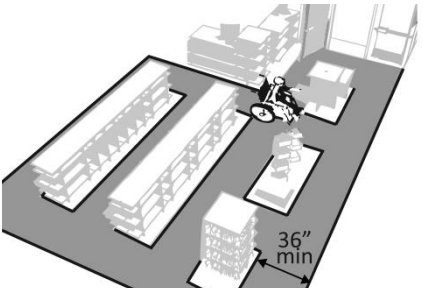
<p>2.47 Are aisles and pathways to goods and services, and to one of each type of sales and service counters, at least 36 inches wide? [403.5.1]</p>	<p><input type="checkbox"/> Yes <input type="checkbox"/> No</p> <p>Measurement: "</p>		<p>Photo #:</p>	<ul style="list-style-type: none"> • Rearrange goods, equipment and furniture • •
---	---	--	-----------------	--



<p>2.48 Are floor surfaces stable, firm and slip resistant? [302.1]</p>	<p><input checked="" type="checkbox"/> Yes <input type="checkbox"/> No</p>		<p>Photo #:</p>	<ul style="list-style-type: none"> • Change floor surface • •
--	--	--	-----------------	--

<p>2.49 If there is carpet:</p> <p>Is it no higher than 1/2 inch?</p> <p>Is it securely attached along the edges?</p> <p>[302.2]</p>	<p><input checked="" type="checkbox"/> Yes <input type="checkbox"/> No</p> <p>Measurement: 1/8"</p> <p><input checked="" type="checkbox"/> Yes <input type="checkbox"/> No</p>		<p>Photo #:</p>	<ul style="list-style-type: none"> • Replace carpet • •
---	--	--	-----------------	--

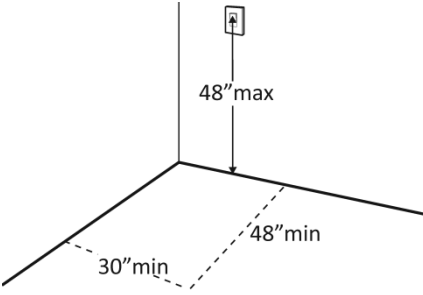

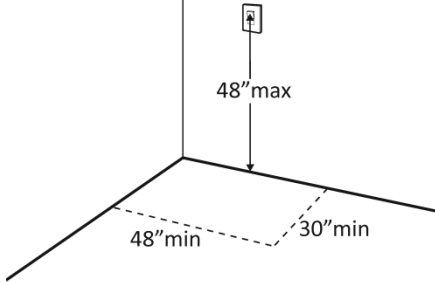
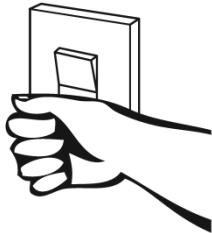
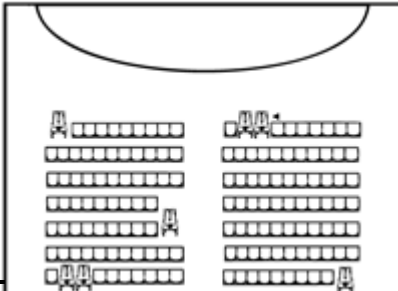
Controls – light switches, security and intercom systems, emergency/alarm boxes, etc.

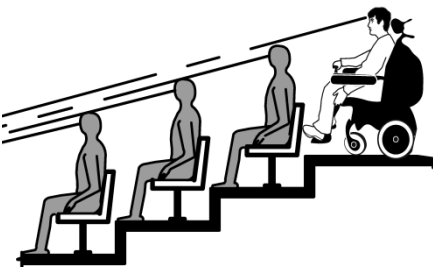
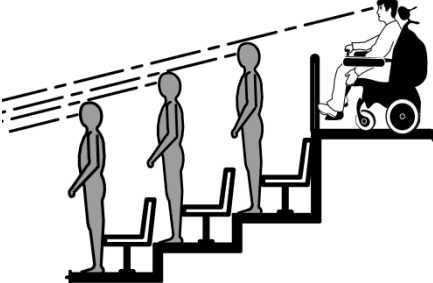
<p>2.50 Is there a clear floor space at least 30 inches wide by at least 48 inches long for a forward or parallel approach? [305.3]</p> <p>Are the operable parts no higher than 48 inches above the floor?*</p> <p>[309.3, 308]</p>	<p><input type="checkbox"/> Yes <input type="checkbox"/> No</p> <p>Measurement:</p> <p><input type="checkbox"/> Yes <input type="checkbox"/> No</p> <p>Measurement:</p>		<p>NA</p>	<ul style="list-style-type: none"> • Change height of control • • <p>*If constructed before 3/15/2012 and a parallel approach is provided, controls can be 54 inches above the floor</p>
---	---	--	-----------	---

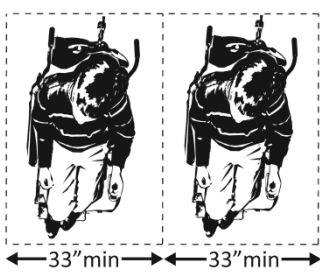
			<p>Photo #:</p>													
<p>2.51 Can the control be operated with one hand and without tight grasping, pinching, or twisting of the wrist? [309.4]</p>	<p><input type="checkbox"/> Yes <input type="checkbox"/> No</p>		<p>Photo #:</p>	<ul style="list-style-type: none"> • Replace control • • 												
<p>Seating: Assembly Areas – theaters, auditoriums, stadiums, theater style classrooms, etc.</p>																
<p>2.52 Are an adequate number of wheelchair spaces provided? [221.2.1]</p>	<p><input type="checkbox"/> Yes <input type="checkbox"/> No</p> <p>Total #:</p> <p>Wheelchair #:</p>	<table border="1" style="width: 100%; border-collapse: collapse;"> <thead> <tr> <th style="text-align: center;"># of Seats</th> <th style="text-align: center;">Wheelchair Spaces</th> </tr> </thead> <tbody> <tr> <td style="text-align: center;">4 - 25</td> <td style="text-align: center;">1</td> </tr> <tr> <td style="text-align: center;">26 - 50</td> <td style="text-align: center;">2</td> </tr> <tr> <td style="text-align: center;">51 - 150</td> <td style="text-align: center;">4</td> </tr> <tr> <td style="text-align: center;">151 - 300</td> <td style="text-align: center;">5</td> </tr> <tr> <td colspan="2" style="text-align: center;">300+ see 2010 Standards 221.2.1.</td> </tr> </tbody> </table>	# of Seats	Wheelchair Spaces	4 - 25	1	26 - 50	2	51 - 150	4	151 - 300	5	300+ see 2010 Standards 221.2.1.		<p>NA</p> <p>Photo #:</p>	<ul style="list-style-type: none"> • Reconfigure to add wheelchair spaces • •
# of Seats	Wheelchair Spaces															
4 - 25	1															
26 - 50	2															
51 - 150	4															
151 - 300	5															
300+ see 2010 Standards 221.2.1.																
<p>2.53 Are wheelchair spaces dispersed to allow location choices and viewing angles equivalent to other seating, including specialty seating areas that provide distinct services and amenities? [221.2.3]</p>	<p><input type="checkbox"/> Yes <input type="checkbox"/> No</p>		<p>NA</p> <p>Photo #:</p>	<ul style="list-style-type: none"> • Reconfigure to disperse wheelchair spaces • • 												

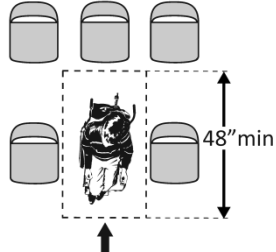
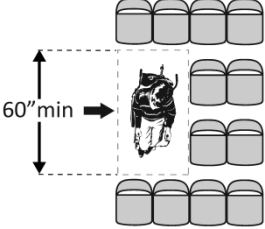
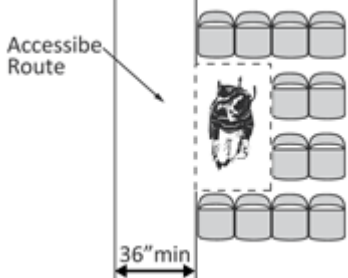
<p>2.54 Where people are expected to remain seated, do people in wheelchair spaces have a clear line of sight over and between the heads of others in front of them? [802.2.1.1, 802.1.1.2]</p>	<p><input type="checkbox"/> Yes <input type="checkbox"/> No</p>		<p>NA</p> <p>Photo #:</p>	<ul style="list-style-type: none"> • Alter for line of sight • •
<p>2.55 Where people are expected to stand, do people in wheelchair spaces have a clear line of sight over and between the heads of others in front of them? [802.2.2.1, 802.1.2.2]</p>	<p><input type="checkbox"/> Yes <input type="checkbox"/> No</p>		<p>NA</p> <p>Photo #:</p>	<ul style="list-style-type: none"> • Alter for line of sight • •
<p>2.56 If there is a single wheelchair space, is it at least 36 inches wide? [802.1.2]</p>	<p><input type="checkbox"/> Yes <input type="checkbox"/> No</p> <p>Measurement:</p>		<p>NA</p> <p>Photo #:</p>	<ul style="list-style-type: none"> • Alter space • •
<p>2.57 If there are two adjacent wheelchair spaces, are they each at least 33 inches wide? [802.1.2]</p>	<p><input type="checkbox"/> Yes <input type="checkbox"/> No</p> <p>Measurement:</p>		<p>NA</p> <p>Photo #:</p>	<ul style="list-style-type: none"> • Alter spaces • •

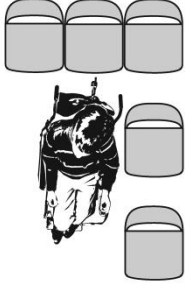
<p>2.58 If the wheelchair space can be entered from the front or rear, is it at least 48 inches deep? [802.1.3]</p>	<p><input type="checkbox"/> Yes <input type="checkbox"/> No Measurement:</p>		<p>NA Photo #:</p>	<ul style="list-style-type: none"> • Alter space • •
<p>2.59 If the wheelchair space can only be entered from the side, is it at least 60 inches deep? [802.1.3]</p>	<p><input type="checkbox"/> Yes <input type="checkbox"/> No Measurement:</p>		<p>NA Photo #:</p>	<ul style="list-style-type: none"> • Alter space • •
<p>2.60 Do wheelchair spaces adjoin, but not overlap, accessible routes? [802.1.4]</p>	<p><input type="checkbox"/> Yes <input type="checkbox"/> No</p>		<p>NA Photo #:</p>	<ul style="list-style-type: none"> • Alter spaces • •
<p>2.61 Is there at least one companion seat for each wheelchair space? [221.3]</p>	<p><input type="checkbox"/> Yes <input type="checkbox"/> No</p>		<p>NA Photo #:</p>	<ul style="list-style-type: none"> • Add companion seats • •

<p>2.62 Is the companion seat located so the companion is shoulder-to-shoulder with the person in a wheelchair? [802.3.1]</p>	<p><input type="checkbox"/> Yes <input type="checkbox"/> No</p>		<p>NA</p> <p>Photo #:</p>	<ul style="list-style-type: none"> • Alter seating • •
<p>2.63 Is the companion seat equivalent in size, quality, comfort and amenities to seating in the immediate area? [802.3.2]</p>	<p><input type="checkbox"/> Yes <input type="checkbox"/> No</p>		<p>NA</p> <p>Photo #:</p>	<ul style="list-style-type: none"> • Add equivalent seating • •
<p>Seating: At dining surfaces (restaurants, cafeterias, bars, etc.) and non-employee work surfaces (libraries, conference rooms, etc.)</p>				
<p>2.64 Are at least 5%, but no fewer than one, of seating and standing spaces accessible for people who use wheelchairs? [226.1]</p>	<p><input type="checkbox"/> Yes <input type="checkbox"/> No</p> <p>Total #:</p> <p>Wheelchair #:</p>		<p>NA</p> <p>Photo #:</p>	<ul style="list-style-type: none"> • Alter to provide accessible spaces • •
<p>2.65 Is there a route at least 36 inches wide to accessible seating? [403.5.1]</p>	<p><input type="checkbox"/> Yes <input type="checkbox"/> No</p> <p>Measurement:</p>		<p>NA</p> <p>Photo #:</p>	<ul style="list-style-type: none"> • Widen route • •

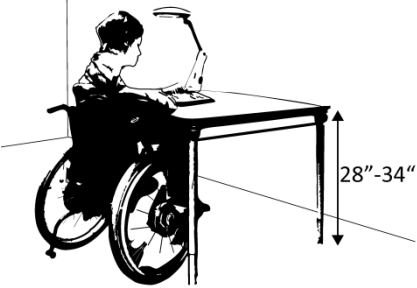
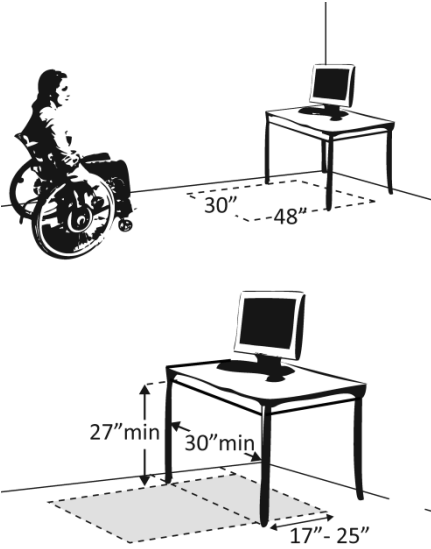
<p>2.66 At the accessible space(s), is the top of the accessible surface no less than 28 inches and no greater than 34 inches above the floor? [902.3]</p> <p>Note: If for children, the top should be no less than 26 inches and no greater than 30 inches above the floor.</p>	<p><input type="checkbox"/> Yes <input type="checkbox"/> No</p> <p>Measurement:</p>		<p>NA</p> <p>Photo #:</p>	<ul style="list-style-type: none"> • Alter surface height • •
<p>2.67 Is there a clear floor space at least 30 inches wide by at least 48 inches long for a forward approach? [305.3]</p> <p>Does it extend no less than 17 inches and no greater than 25 inches under the surface? [306.2, 306.3]</p> <p>Is there knee space at least 27 inches high and at least 30 inches wide? [306.2, 306.3]</p> <p>Note: If for children, the knee space may be 24 inches high.</p>	<p><input type="checkbox"/> Yes <input type="checkbox"/> No</p> <p>Measurement:</p> <p><input type="checkbox"/> Yes <input type="checkbox"/> No</p> <p>Measurement:</p> <p><input type="checkbox"/> Yes <input type="checkbox"/> No</p> <p>Measurement:</p>		<p>NA</p> <p>Photo #:</p>	<ul style="list-style-type: none"> • Alter table or work surface • Add accessible table or work surface •

Seating: General – reception areas, waiting rooms, etc.

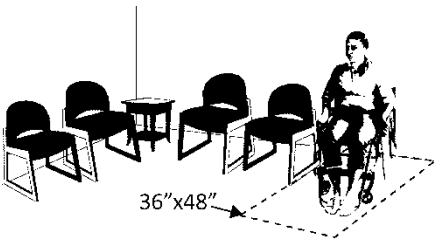
<p>2.68 Is there at least one space at least 36 inches wide by at least 48 inches long for a person in a wheelchair? [802.1.2, 802.1.3]</p>	<p><input type="checkbox"/> Yes <input checked="" type="checkbox"/> No</p> <p>Measurement: "</p>		<p>Photo #:</p>	<ul style="list-style-type: none"> • Move furniture and equipment to provide space • •
--	--	--	-----------------	---

Benches – In locker rooms, dressing rooms, fitting rooms This section does not apply to any other benches.

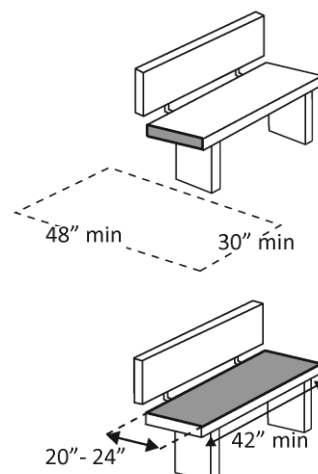
<p>2.69 In locker rooms, dressing rooms and fitting rooms, is there at least one room with a bench? [222.1, 803.4]</p>	<p><input type="checkbox"/> Yes <input type="checkbox"/> No</p>		<p>NA</p> <p>Photo #:</p>	<ul style="list-style-type: none"> • Add bench • •
<p>2.70 Is there a clear floor space at least 30 inches wide by at least 48 inches long at the end of the bench and parallel to the short axis of the bench?</p> <p>Is the bench seat at least 42 inches long and no less than 20 inches and no greater than 24 inches deep?</p> <p>Does the bench have back support or is it affixed to a wall?</p> <p>Is the top of the bench seat no less than 17 inches and no greater than 19 inches above the floor? [903]</p>	<p><input type="checkbox"/> Yes <input type="checkbox"/> No</p> <p>Measurement:</p> <p><input type="checkbox"/> Yes <input type="checkbox"/> No</p> <p>Measurement:</p> <p><input type="checkbox"/> Yes <input type="checkbox"/> No</p> <p>Measurement:</p>		<p>NA</p>	<ul style="list-style-type: none"> • Move bench • Replace bench • Affix bench to wall • •

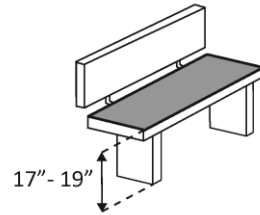

Photo #:

Check-Out Aisles – supermarkets, large retail stores, etc.

2.71 Is the aisle at least 36 inches wide?
[904.3.1]

Yes No

Measurement:

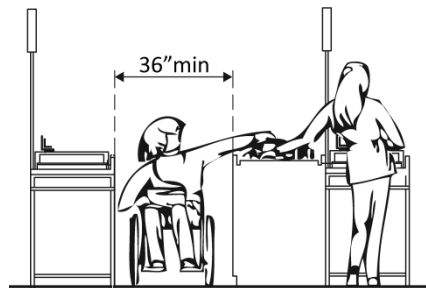

NA

Photo #:

- Widen aisle
-
-

2.72 Is the counter surface of at least one aisle no higher than 38 inches above the floor?
[904.3.2]

Yes No

Measurement:

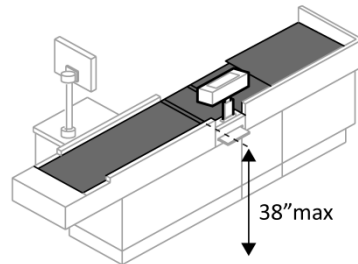

NA

Photo #:

- Lower counter
-
-

2.73 Is the top of the counter edge protection no higher than 2 inches above the counter surface?
[904.3.2]

Yes No

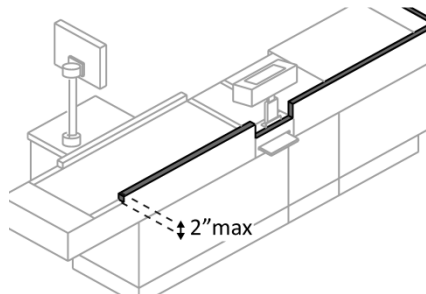

Measurement:



NA

Photo #:

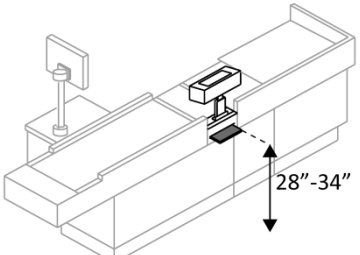
- Lower edge protection
-
-

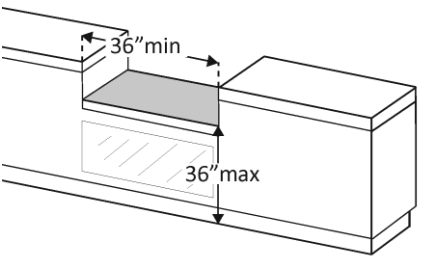
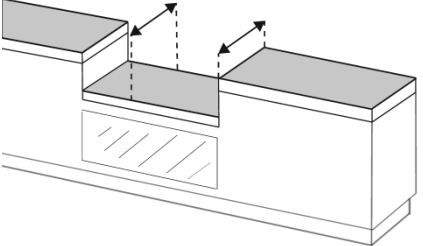
<p>2.74 If there is a check writing surface, is the top no less than 28 inches and no greater than 34 inches above the floor? [904.3.3]</p>	<p><input type="checkbox"/> Yes <input type="checkbox"/> No Measurement:</p>		<p>NA Photo #:</p>	<ul style="list-style-type: none"> • Alter check writing surface • •
<p>2.75 If there is more than one check-out aisle is there a sign with the International Symbol of Accessibility at the accessible aisle? [216.11]</p>	<p><input type="checkbox"/> Yes <input type="checkbox"/> No</p>		<p>NA Photo #:</p>	<ul style="list-style-type: none"> • Add sign • •
<p>Sales & Service Counters – banks, stores, dry cleaners, auto repair shops, fitness clubs, etc.</p>				
<p>2.76 Is there a portion of at least one of each type of counter that is: No higher than 36 inches above the floor? At least 36 inches long? [904.4.1]</p>	<p><input type="checkbox"/> Yes <input checked="" type="checkbox"/> No Measurement: 42" <input type="checkbox"/> Yes <input type="checkbox"/> No Measurement:</p>		<p>Photo #:</p>	<ul style="list-style-type: none"> • Lower section of counter • Lengthen section of counter •
<p>2.77 Does the accessible portion of the counter extend the same depth as the counter top? [904.4]</p>	<p><input type="checkbox"/> Yes <input checked="" type="checkbox"/> No Measurement: 32"</p>		<p>Photo #:</p>	<ul style="list-style-type: none"> • Alter accessible portion • •

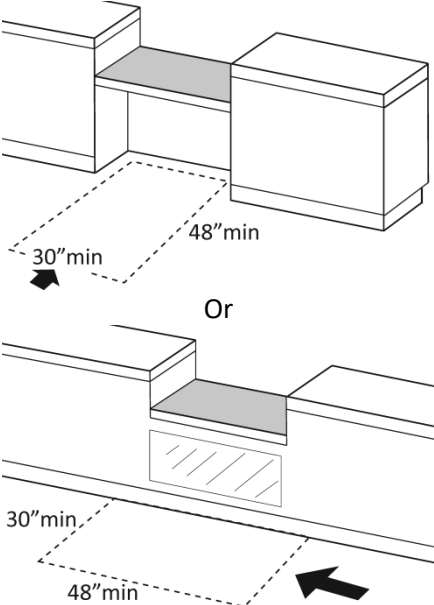
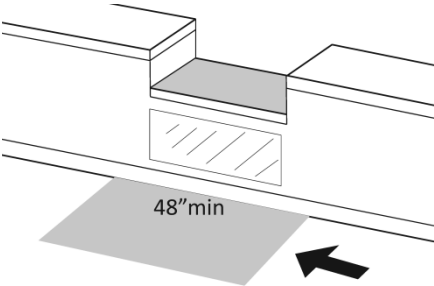
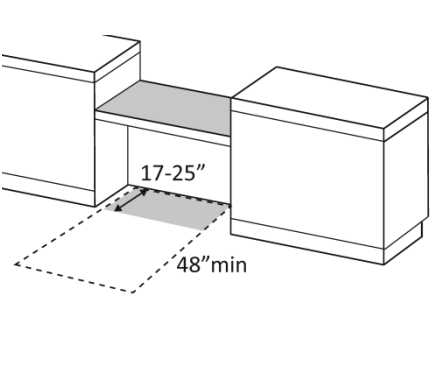
<p>2.78 Is there a clear floor space at least 30 inches wide by at least 48 inches long for a forward or parallel approach? [904.4]</p> <p><input checked="" type="checkbox"/> Yes <input type="checkbox"/> No</p> <p><input type="checkbox"/> Parallel Measurement:</p> <p><input checked="" type="checkbox"/> Forward Measurement: 72"</p>	<p><input checked="" type="checkbox"/> Yes <input type="checkbox"/> No</p> <p><input type="checkbox"/> Parallel Measurement:</p> <p><input checked="" type="checkbox"/> Forward Measurement: 72"</p>		<p>Photo #:</p>	<ul style="list-style-type: none"> • Reconfigure to provide a parallel or forward approach • •
<p>2.79 For a parallel approach, is the clear floor space positioned with the 48 inches adjacent to the accessible length of counter? [904.4.1]</p> <p><input type="checkbox"/> Yes <input type="checkbox"/> No</p> <p>Measurement: "</p>	<p><input type="checkbox"/> Yes <input type="checkbox"/> No</p> <p>Measurement: "</p>		<p>Photo #:</p>	<ul style="list-style-type: none"> • If a parallel approach is not possible, a forward approach is required • •
<p>2.80 For a forward approach:</p> <p>Do no less than 17 and no greater than 25 inches of the clear floor space extend under the accessible length of the counter? [306.2.2, 306.2.3]</p> <p>Is there at least 27 inches</p>	<p><input type="checkbox"/> Yes <input type="checkbox"/> No</p> <p>Measurement:</p> <p><input type="checkbox"/> Yes <input type="checkbox"/> No</p>		<p>Photo #:</p>	<ul style="list-style-type: none"> • Reconfigure to provide knee clearance • •

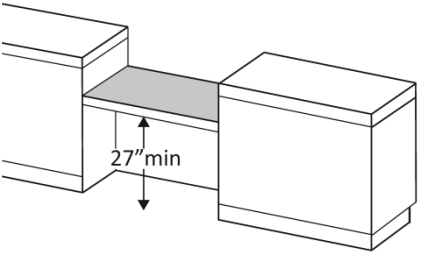
<p>clearance from the floor to the bottom of the counter? [306.3.1]</p>	<p>Measurement: "</p>		<p>Photo #:</p>	
---	---------------------------	--	-----------------	--

Food Service Lines – in cafeterias, salad bars, eat-in fast food establishments, etc.

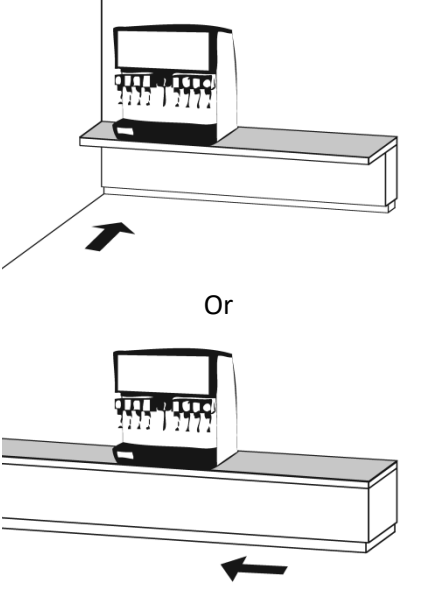
<p>2.81 Does at least one of each type of self-service shelf or dispensing device for tableware, dishware, condiments, food and beverages have a forward or parallel approach? [904.5.1]</p>	<p><input type="checkbox"/> Yes <input type="checkbox"/> No</p> <p><input type="checkbox"/> Forward</p> <p><input type="checkbox"/> Parallel</p>		<p>NA</p> <p>Photo #:</p>	<ul style="list-style-type: none"> • Reconfigure to provide approach • •
---	--	---	---------------------------	---

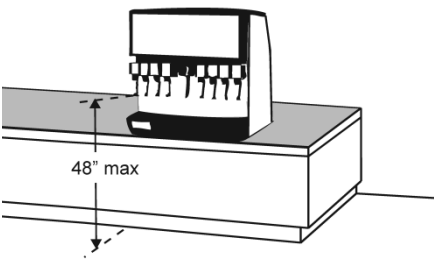
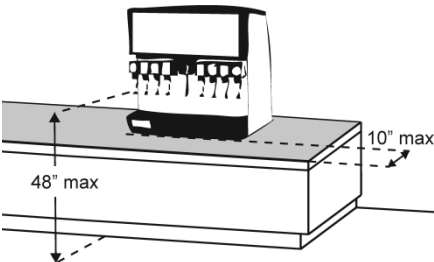
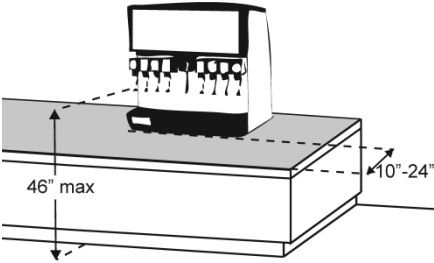
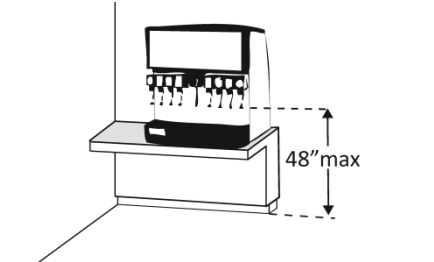
<p>2.82 If there is an unobstructed parallel approach, is the shelf or dispensing device no higher than 48 inches above the floor? [308.3.1]</p>	<p><input type="checkbox"/> Yes <input type="checkbox"/> No Measurement:</p>		<p>NA Photo #:</p>	<ul style="list-style-type: none"> • Lower shelf and/or dispensing device • •
<p>2.83 If there is a shallow obstruction no deeper than 10 inches with a parallel approach, is the shelf or dispensing device no higher than 48 inches above the floor? [308.3.1]</p>	<p><input type="checkbox"/> Yes <input type="checkbox"/> No Measurement:</p>		<p>NA Photo #:</p>	<ul style="list-style-type: none"> • Lower shelf and/or dispensing device • •
<p>2.84 If there is an obstruction no less than 10 inches and no greater than 24 inches deep with a parallel approach, is the shelf or dispensing device no higher than 46 inches above the floor? [308.3.2]</p>	<p><input type="checkbox"/> Yes <input type="checkbox"/> No Measurement:</p>		<p>NA Photo #:</p>	<ul style="list-style-type: none"> • Lower shelf and/or dispensing device • •
<p>2.85 If there is an unobstructed forward approach, is the shelf or dispensing device no higher than 48 inches above the floor? [308.2.1]</p>	<p><input type="checkbox"/> Yes <input type="checkbox"/> No Measurement:</p>		<p>NA Photo #:</p>	<ul style="list-style-type: none"> • Lower shelf and/or dispensing device • •

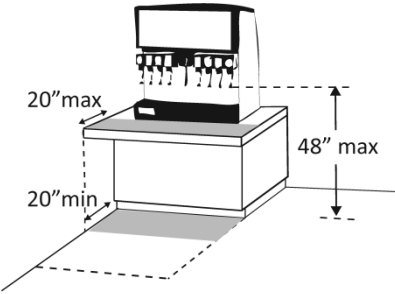
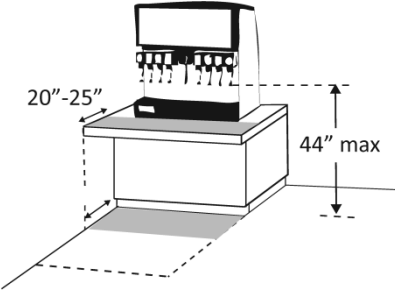
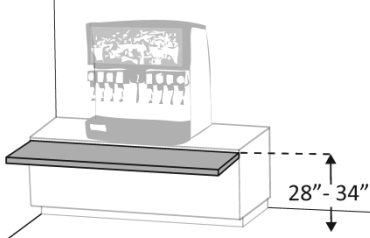
<p>2.86 If there is an obstruction no deeper than 20 inches with a forward approach:</p> <p>Does clear floor space extend under the obstruction that is at least the same depth as the obstruction?</p> <p>Is the shelf or dispensing device no higher than 48 inches above the floor? [904.5.1]</p>	<p><input type="checkbox"/> Yes <input type="checkbox"/> No Measurement:</p> <p><input type="checkbox"/> Yes <input type="checkbox"/> No Measurement:</p>		<p>NA</p> <p>Photo #:</p>	<ul style="list-style-type: none"> • Reconfigure to provide knee space • Lower shelf and/or dispensing device •
<p>2.87 If the obstruction is no less than 20 inches and no greater than 25 inches deep with a forward approach:</p> <p>Does clear floor space extend under the obstruction that is at least the same depth as the obstruction?</p> <p>Is the shelf or dispensing device no higher than 44 inches above the floor? [904.5.1]</p>	<p><input type="checkbox"/> Yes <input type="checkbox"/> No Measurement:</p> <p><input type="checkbox"/> Yes <input type="checkbox"/> No Measurement:</p>		<p>NA</p> <p>Photo #:</p>	<ul style="list-style-type: none"> • Reconfigure to provide knee space • Lower shelf and/or dispensing device •
<p>2.88 If there is a tray slide, is the top no less than 28 inches and no greater than 34 inches above the floor? [904.5.2]</p>	<p><input type="checkbox"/> Yes <input type="checkbox"/> No Measurement:</p>		<p>NA</p> <p>Photo #:</p>	<ul style="list-style-type: none"> • Reconfigure • •

	<input type="checkbox"/> Yes <input type="checkbox"/> No		Photo #:	<ul style="list-style-type: none"> • • •
	<input type="checkbox"/> Yes <input type="checkbox"/> No		Photo #:	<ul style="list-style-type: none"> • • •
	<input type="checkbox"/> Yes <input type="checkbox"/> No		Photo #:	<ul style="list-style-type: none"> • • •
	<input type="checkbox"/> Yes <input type="checkbox"/> No		Photo #:	<ul style="list-style-type: none"> • • •
	<input type="checkbox"/> Yes <input type="checkbox"/> No		Photo #:	<ul style="list-style-type: none"> • • •